

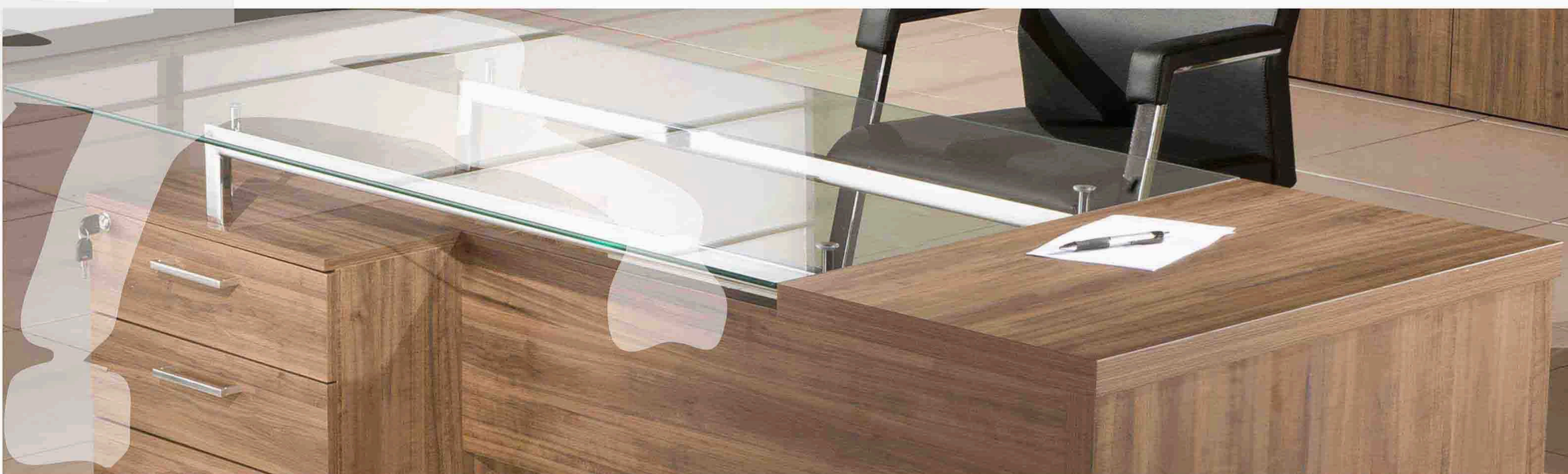

Móveis para Escritório

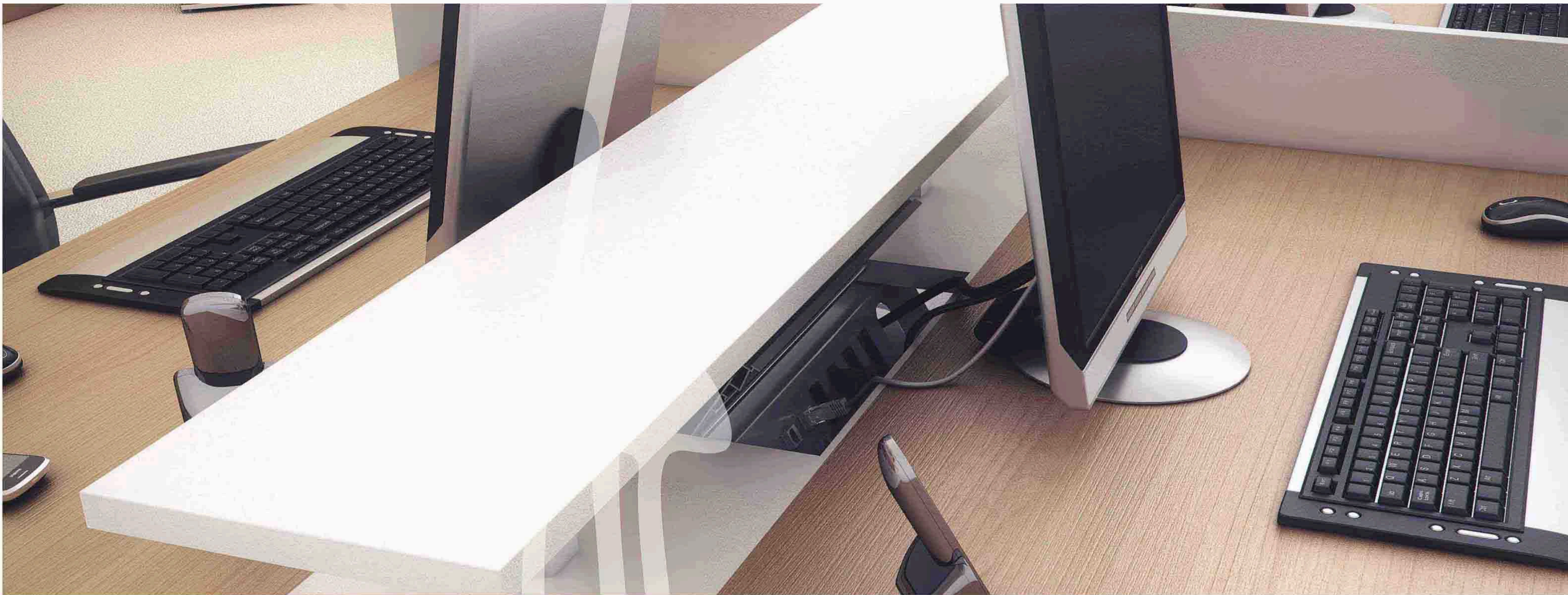

escritórios corporativos



Móveis para Escritório

smartflex

DESDE
1979



SOBRE:

Fornecer mobiliário corporativo de qualidade é nossa premissa número 1.

Baseados na evolução estética, buscando oferecer conforto, funcionalidade, facilmente adaptáveis as transformações do dia a dia, a **Takaya** possui uma história de sucesso.

Com 900m² de instalações próprias entre show room e depósitos, contamos com uma equipe de expertises em soluções e montagens de escritórios, capacitados a orientar, agilizar e racionalizar todas as etapas da criação do seu espaço de trabalho, desde a elaboração de projetos até a finalização, com mínima interferência em ambientes que já se encontrem em funcionamento, obedecendo inclusive, as normas vigentes de ergonomia (NR17).

O planejamento ergonômico do seu ambiente administrativo, industrial, refeitórios e vestiários para seus colaboradores, não visa somente qualidade de vida e o bem estar físico do usuário, mas também objetiva o fluxo de informações e pessoas, resultando em eficiência, economia e produtividade, proporcionados através de projetos gratuitos.

Uma variedade de configurações criativas, de produtos diferenciados, em formações inovadoras, proporcionam ao cliente **Takaya** uma visão inteligente do escritório contemporâneo.

A partir de agora, sua nova identidade corporativa passa pela Takaya



TAKAYA EQUIPAMENTOS P/ ESCRITÓRIO LTDA.

AV. PIRAPORINHA, 736 - VL. NOGUEIRA - CEP 09950-000
DIADEMA - SP - TEL.: (11) 4075-3688 / 4075-3007
SITE: www.takaya.com.br - E-mail: takaya@takaya.com.br



*O grupo Takaya Móveis está constantemente aperfeiçoando seus produtos no design, tecnologia empregada e ergonomia. Sendo assim, poderão ocorrer mudanças nas ilustrações constantes neste catálogo e também nas formas de comercialização. Reservamo-nos o direito de alterações sem aviso prévio. Os dados, descrições, ilustrações e acabamentos são apenas referências. ** Consulte nossas condições de comercialização.

COMPONENTES



linha
ARYA

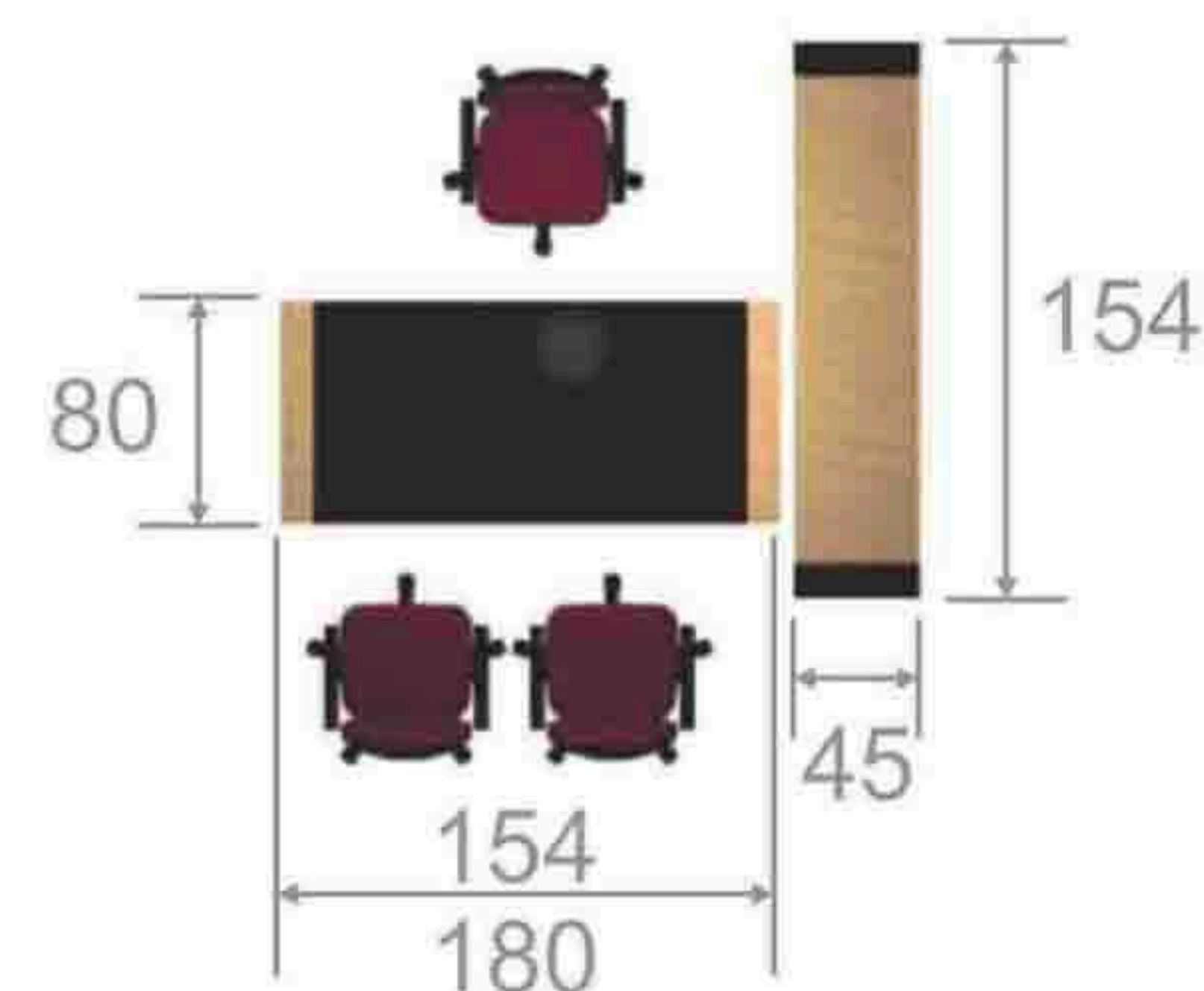

COMPONENTES



linha
ARYA REUNIÃO

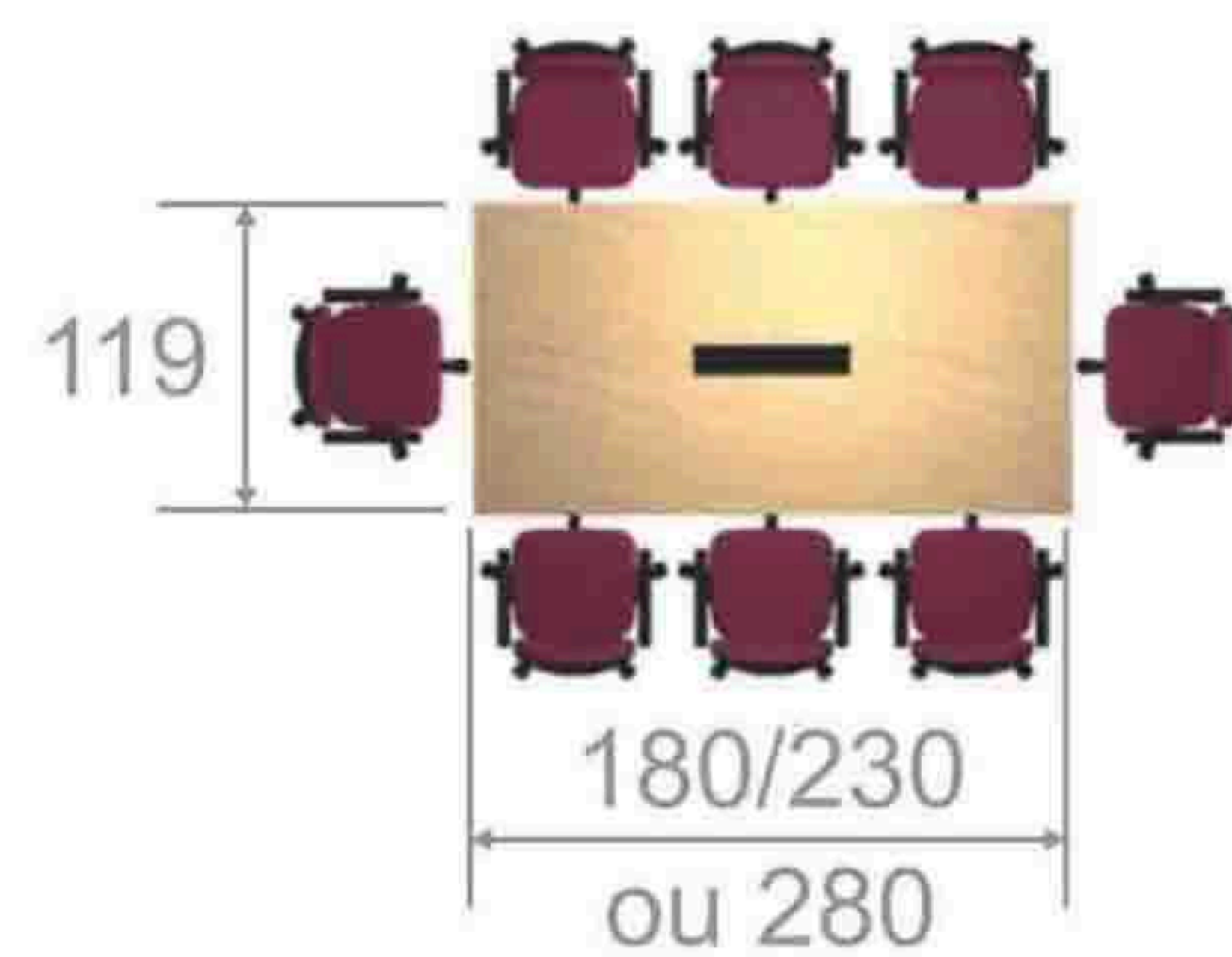

linha
METRIC VIDRO

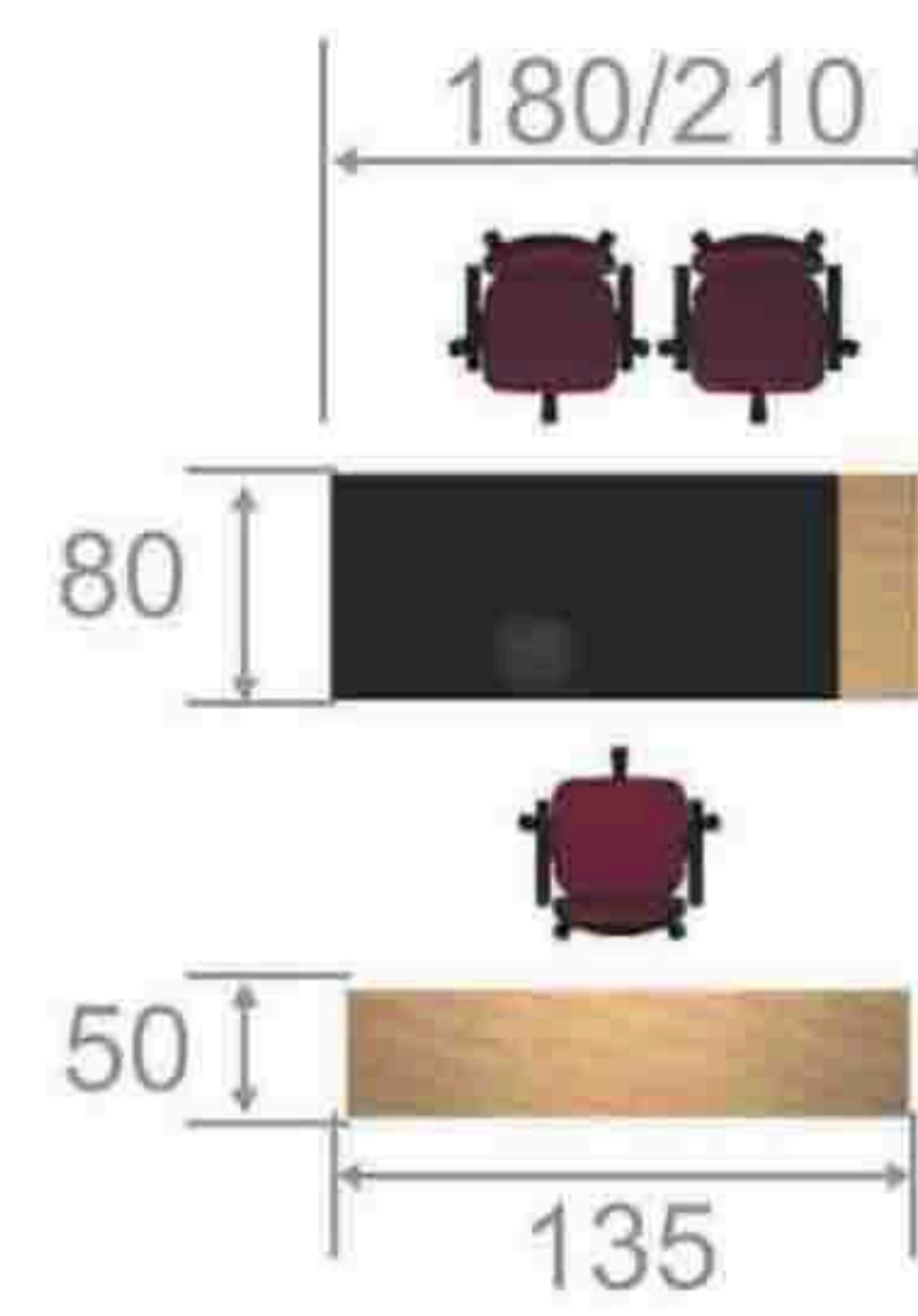

COMPONENTES



linha
METRIC

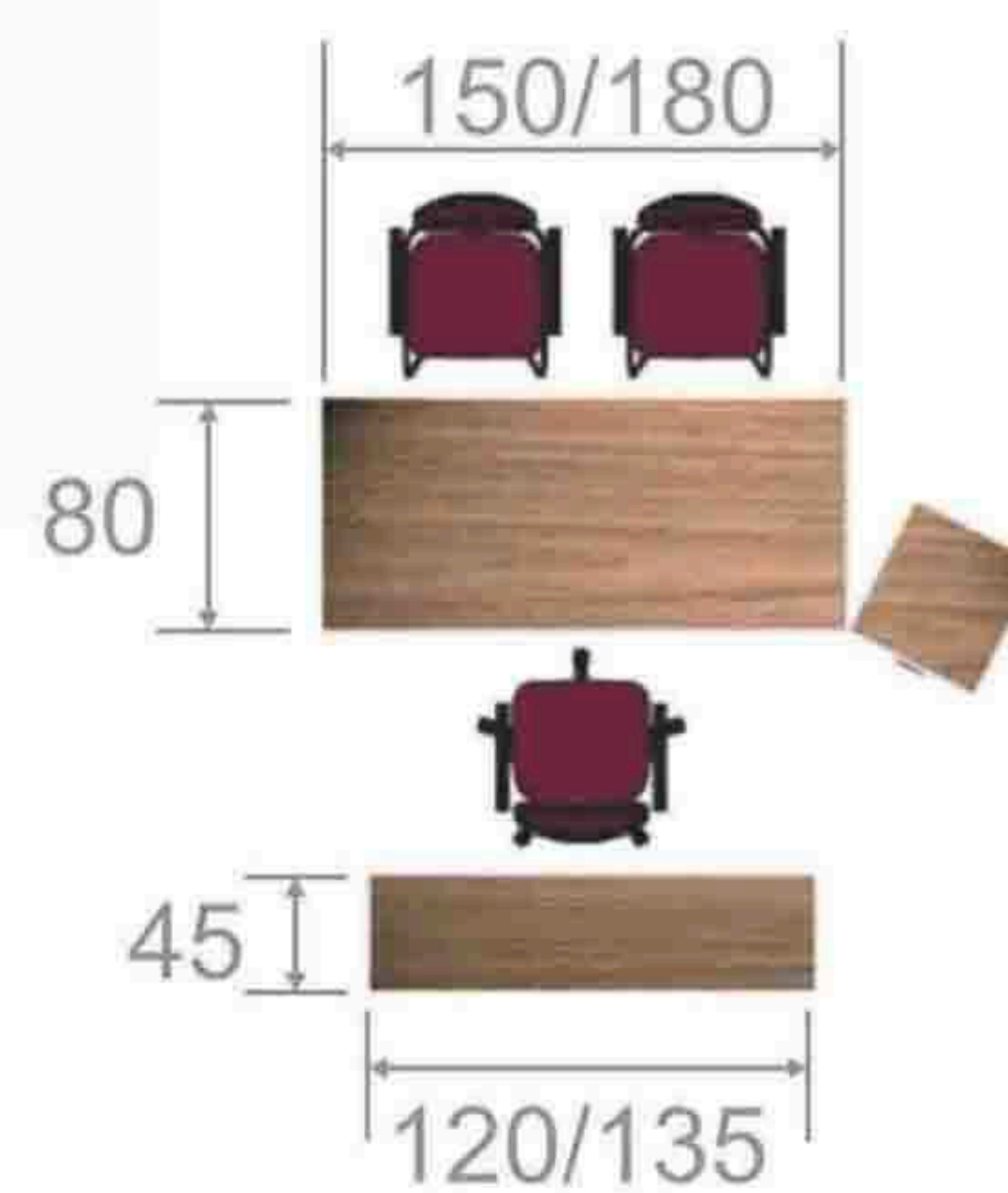

COMPONENTES



COMPONENTES



linha
REFLEX TAMBURATO

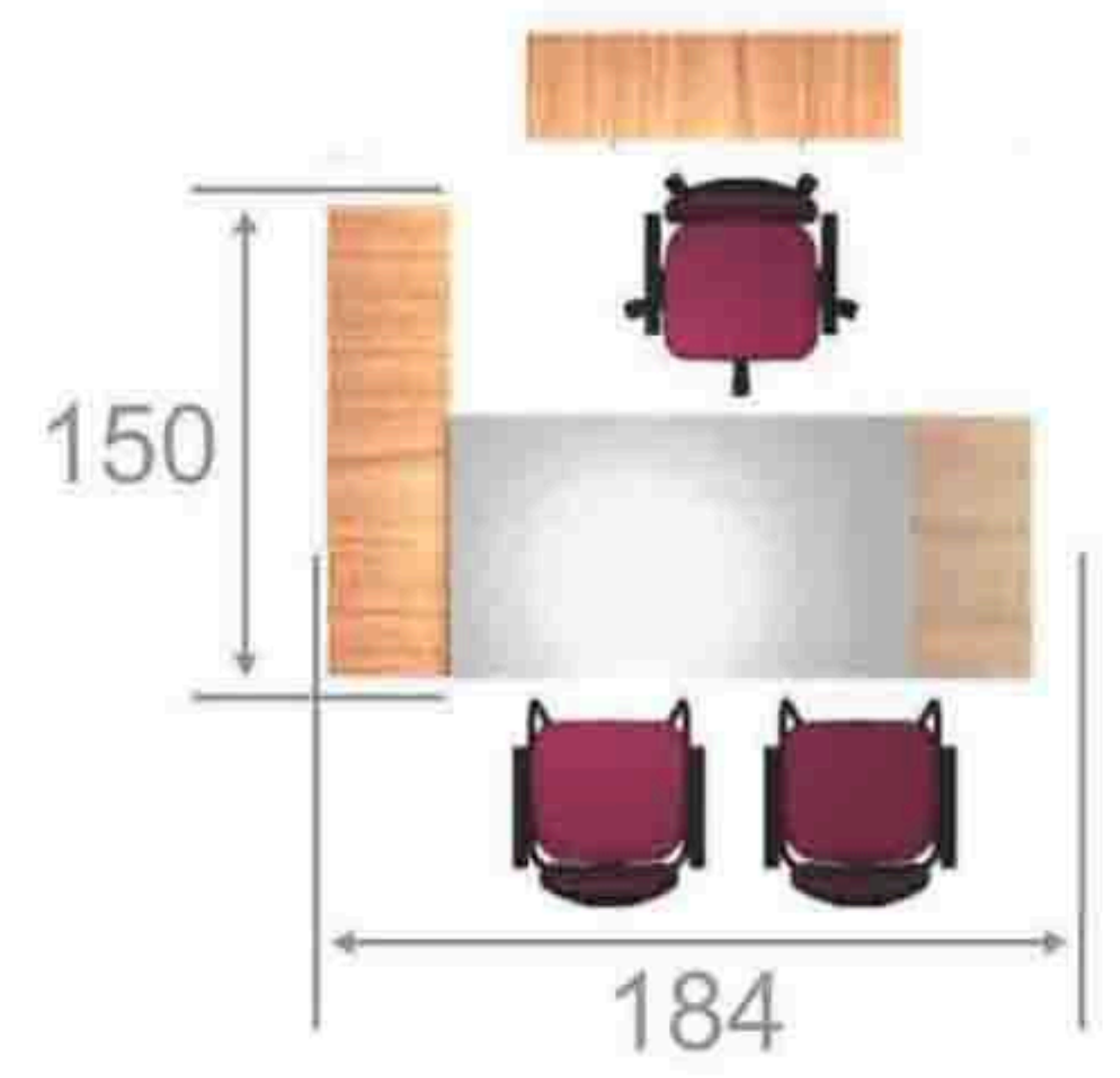

COMPONENTES



linha
DIVERSI

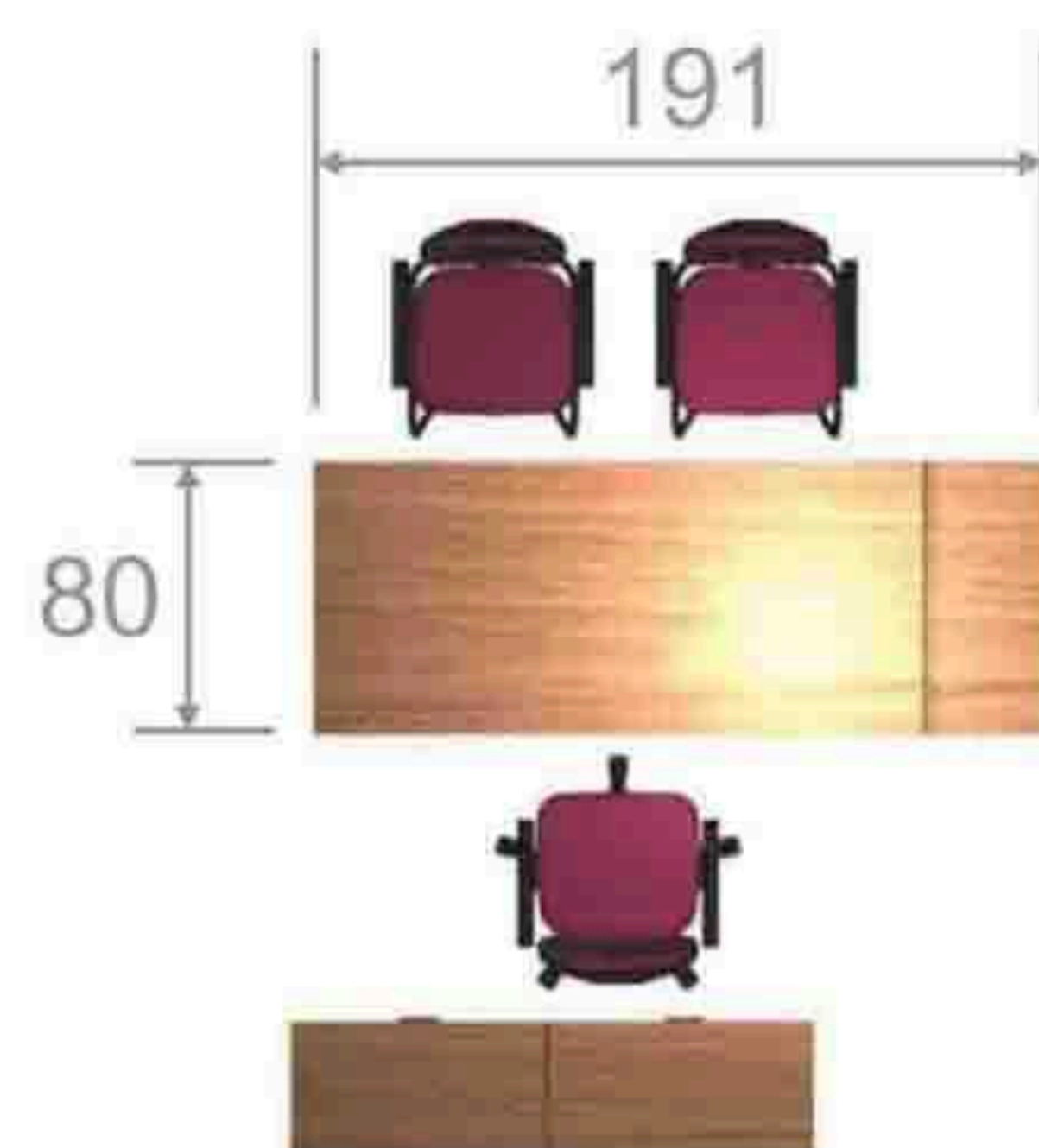

linha
EIFFEL

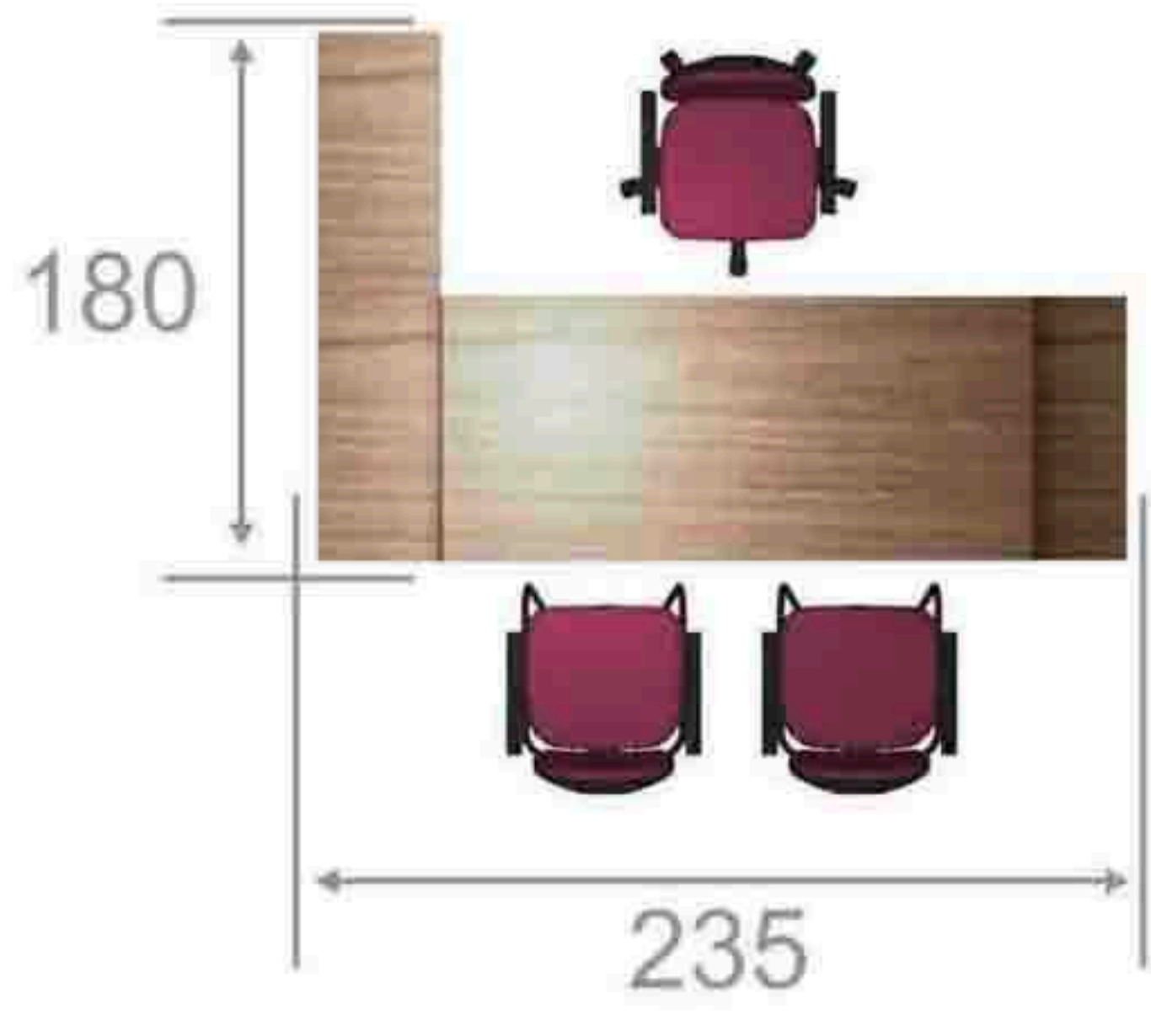

COMPONENTES



linha
TOP

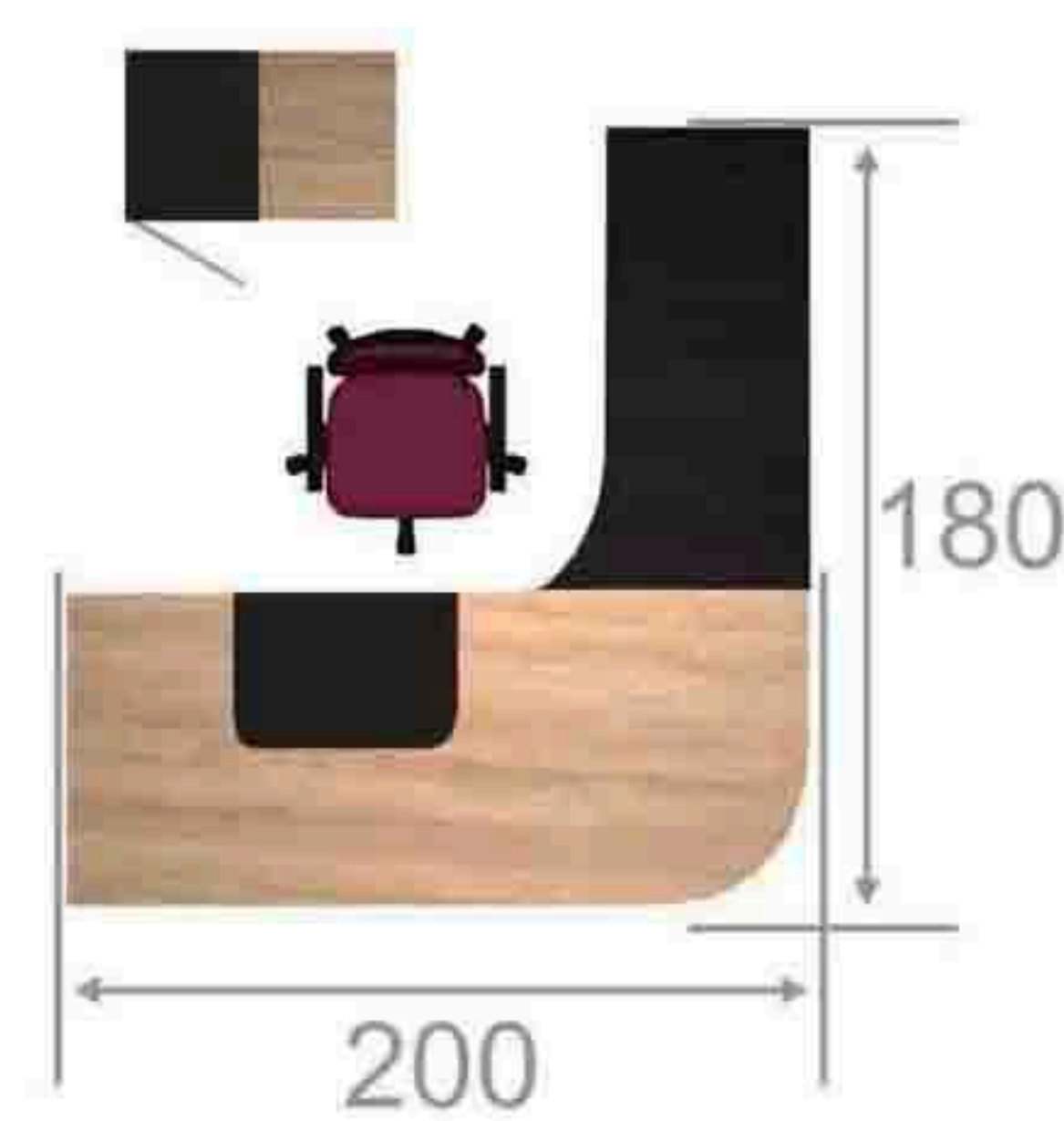

COMPONENTES

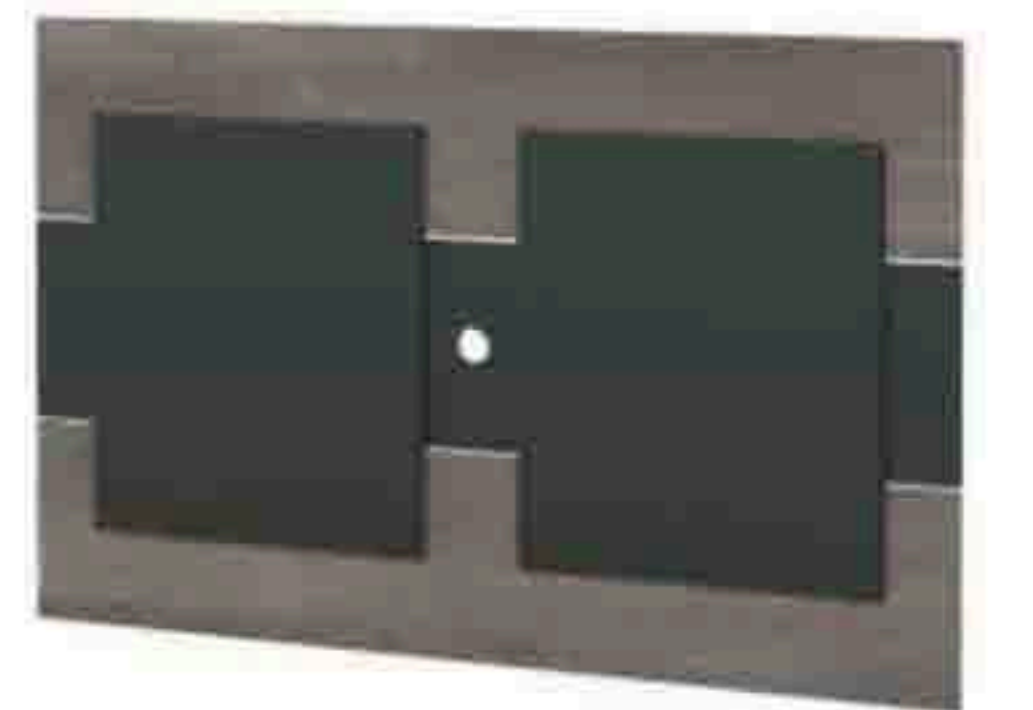

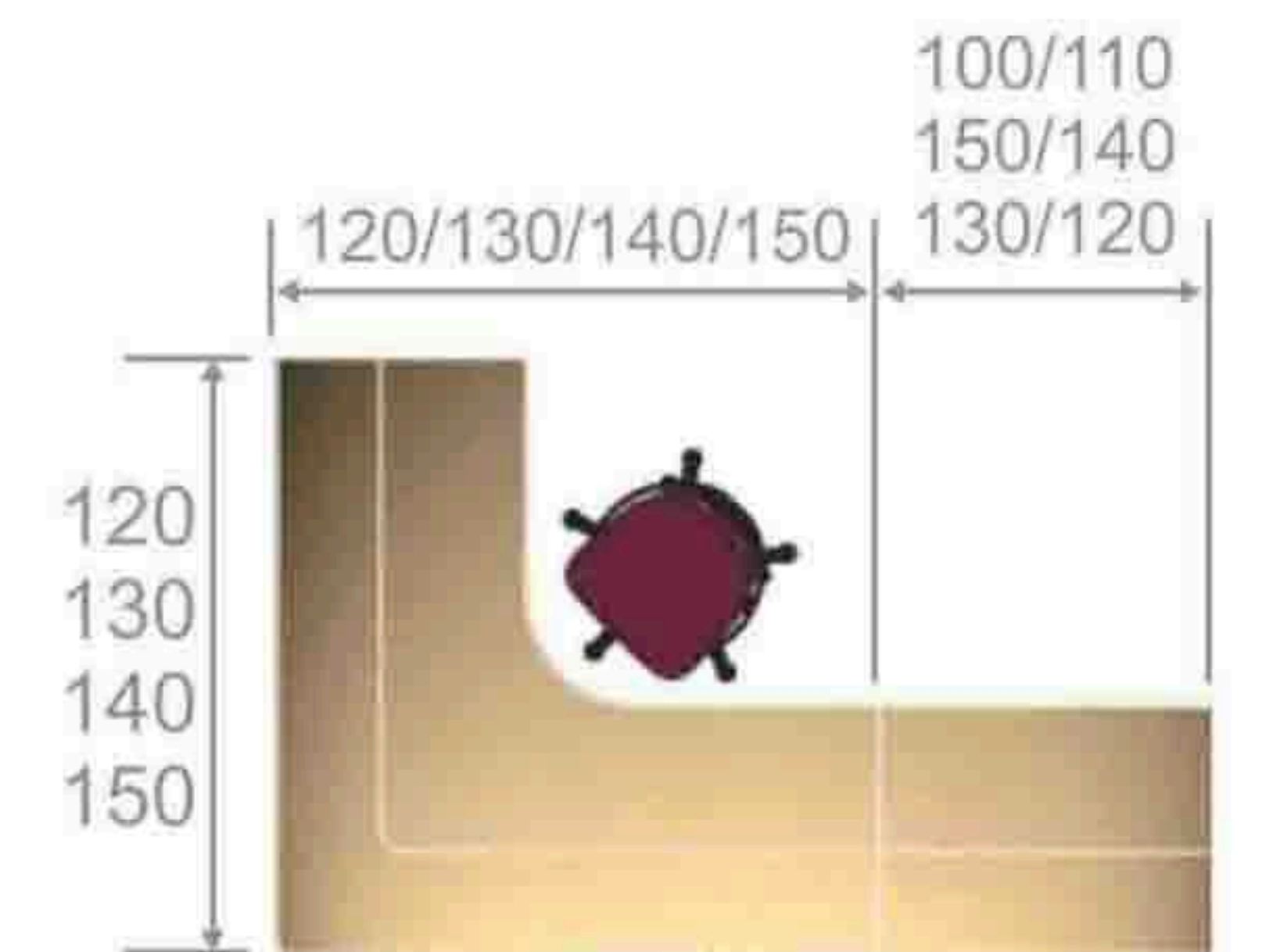
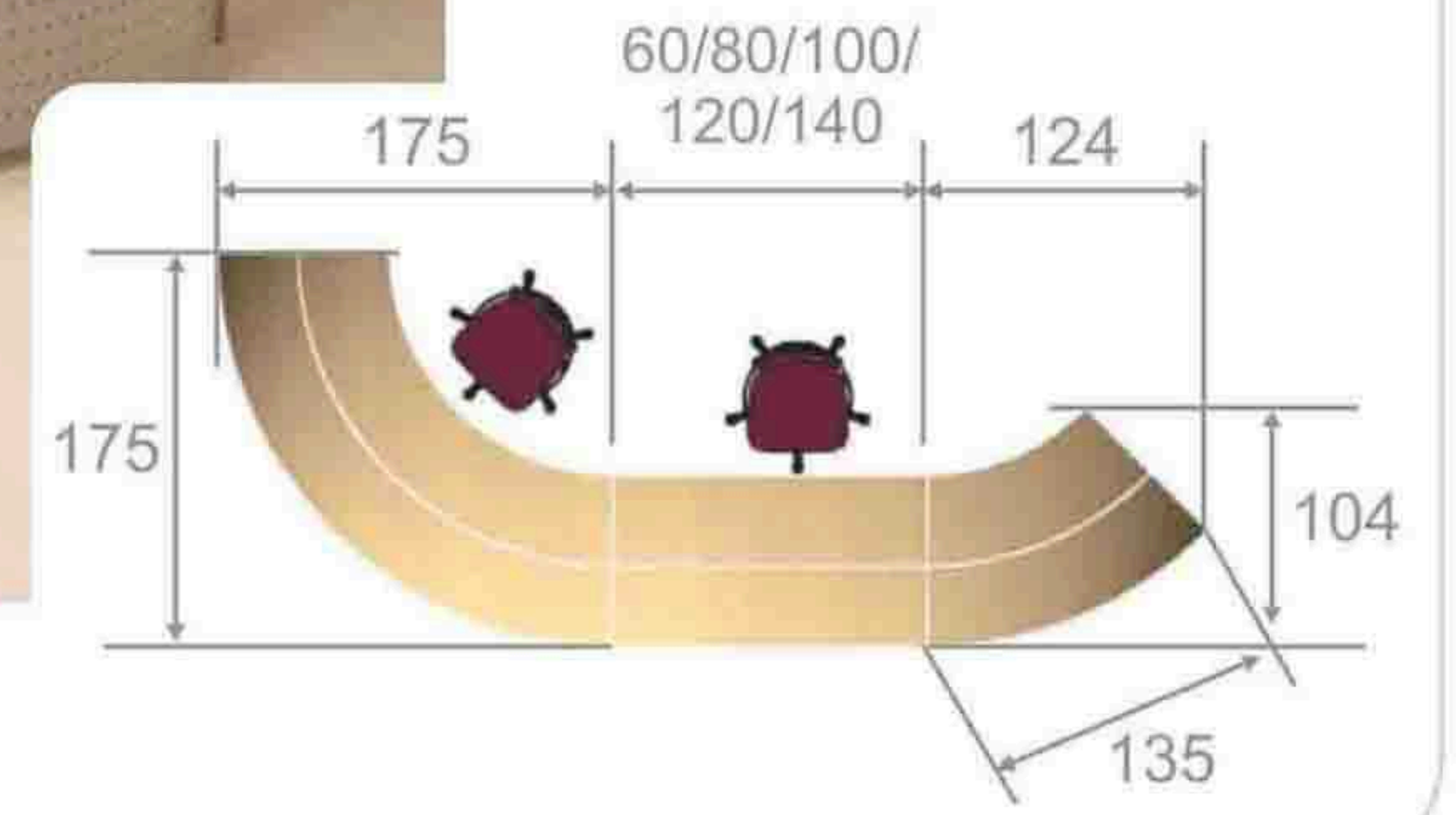

OPÇÕES DE ARMÁRIOS



ESTAÇÕES
INTEGRADAS

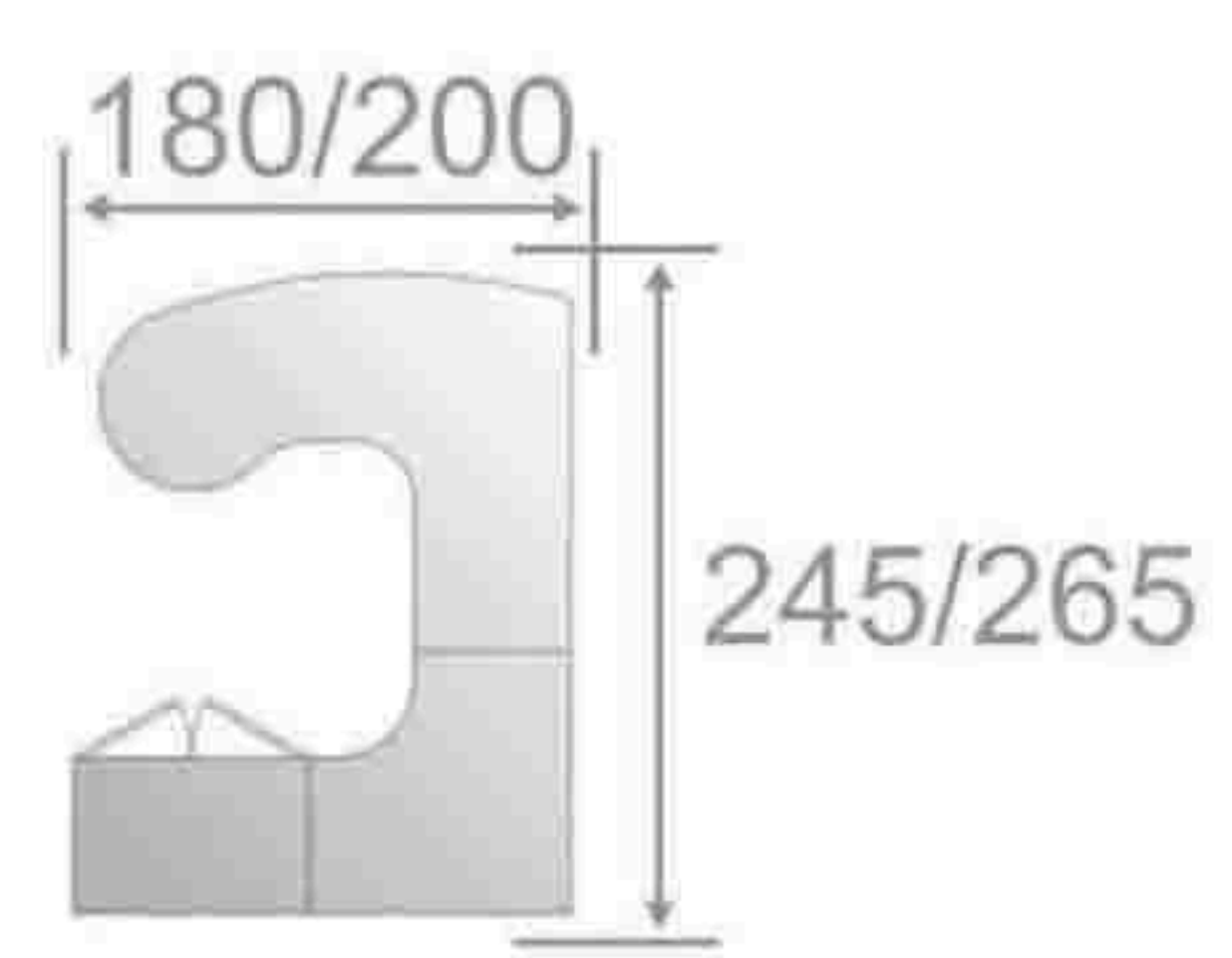
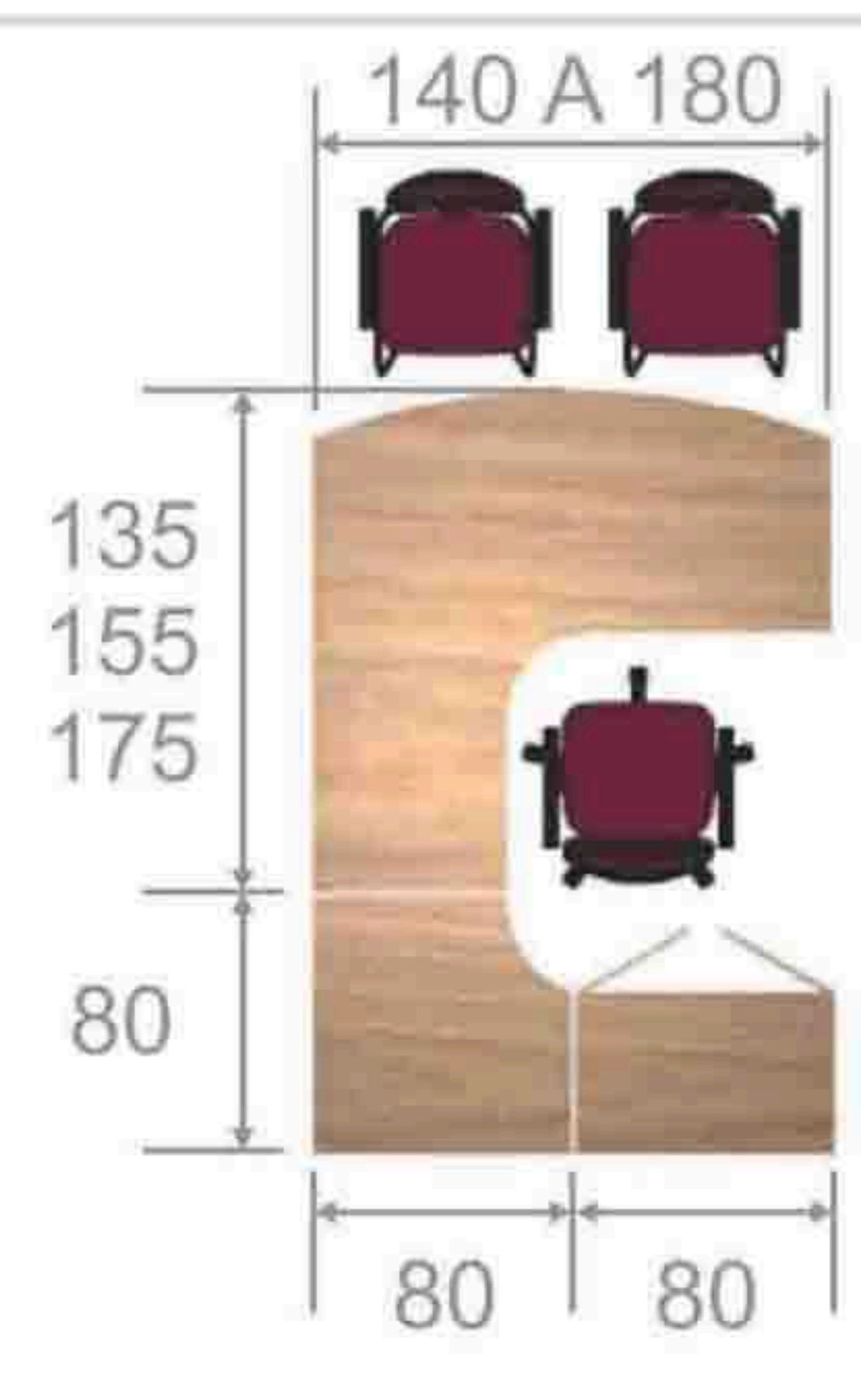

linha
CALLCENTER

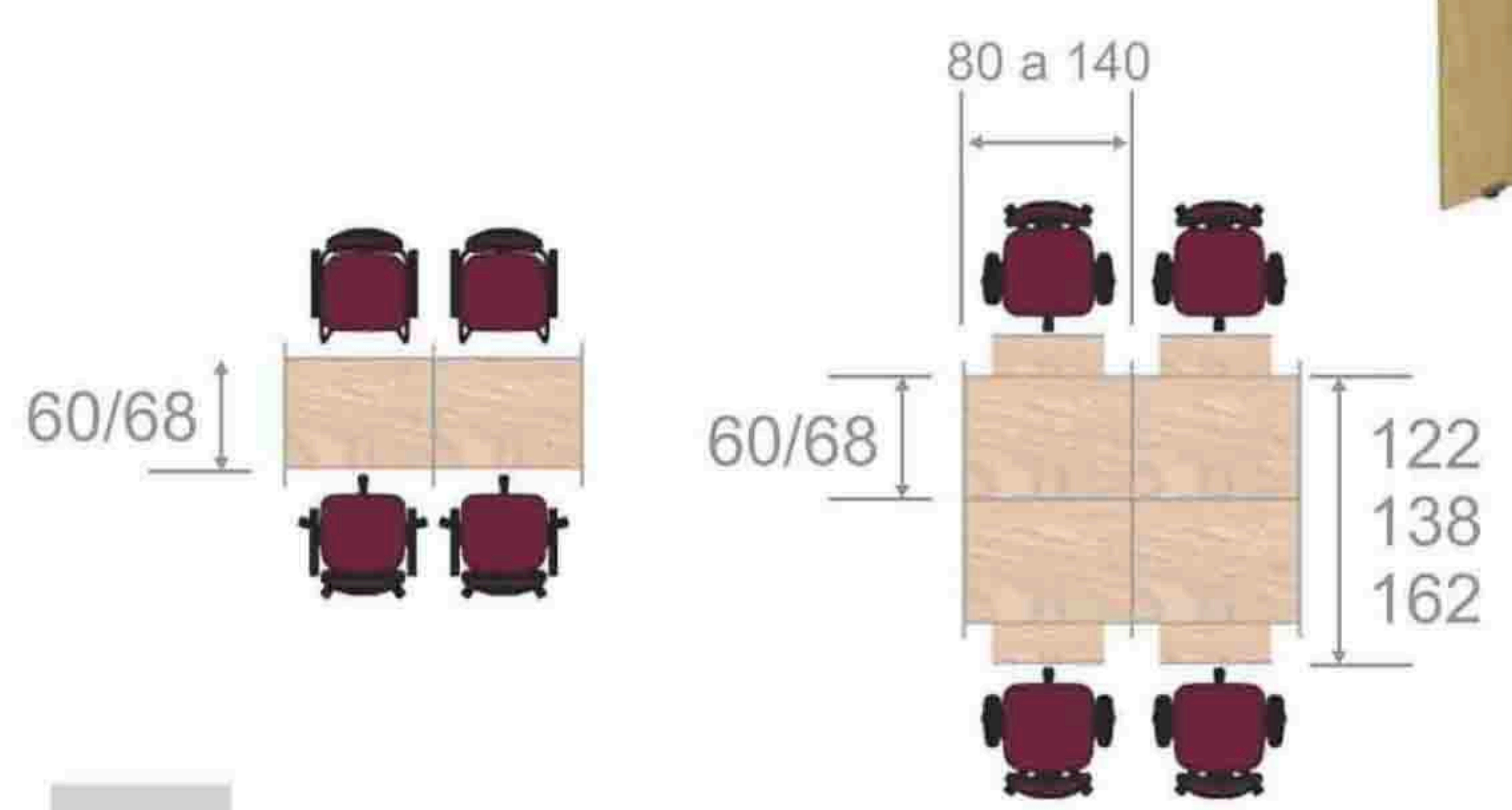
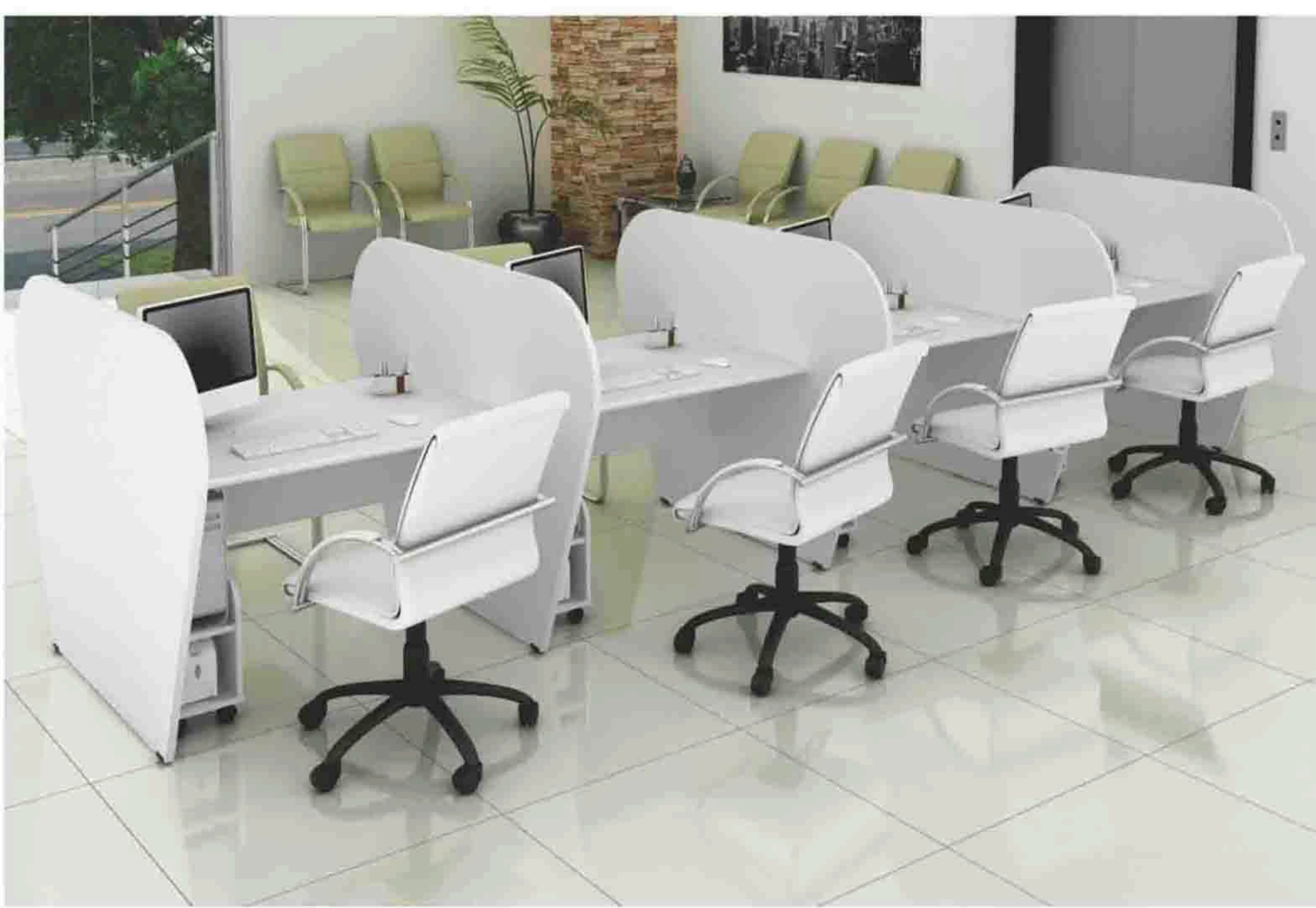

COMPONENTES



ESTAÇÃO DIX FORMATO TREVO



ESTAÇÃO CLIP FORMATO T

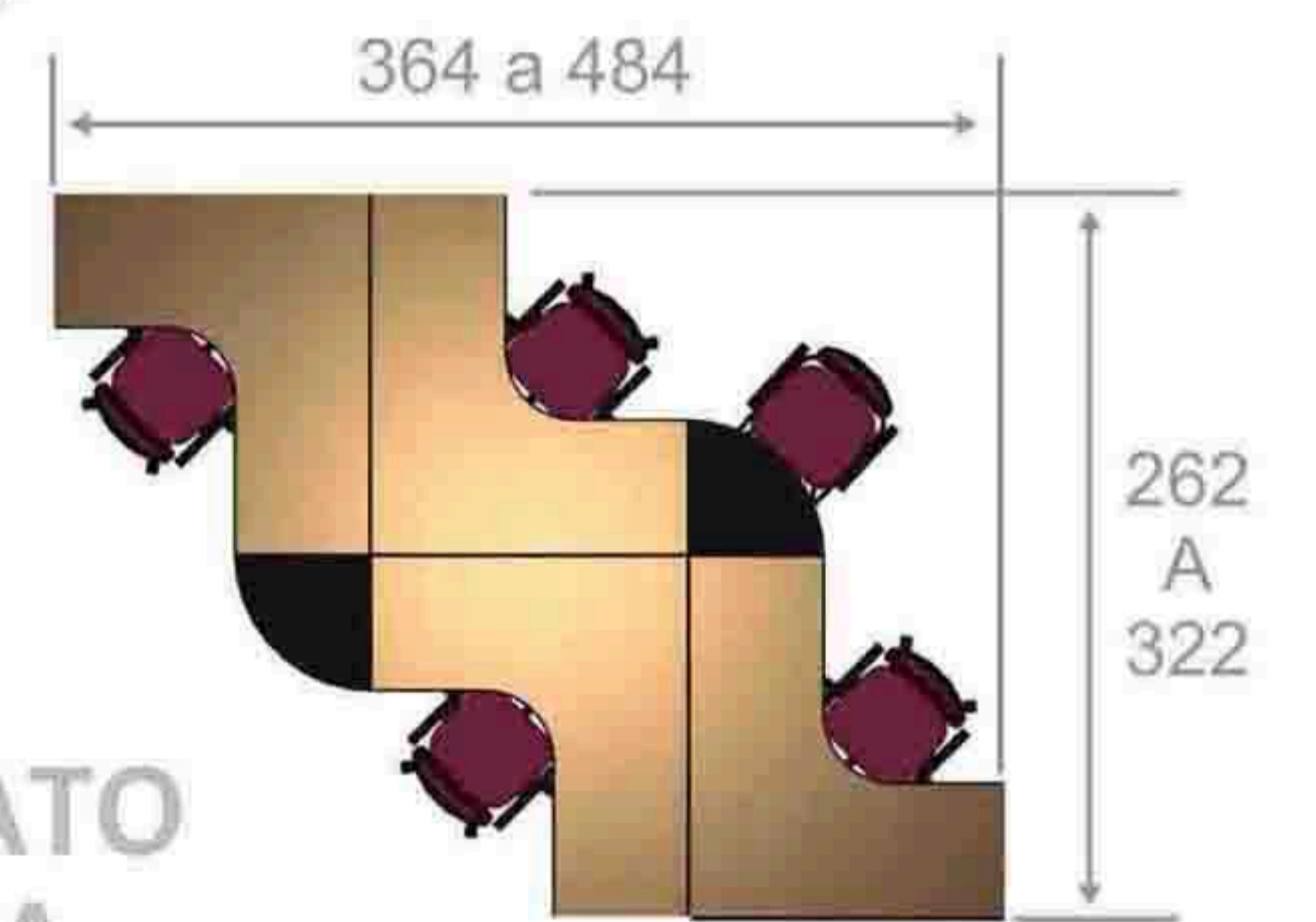
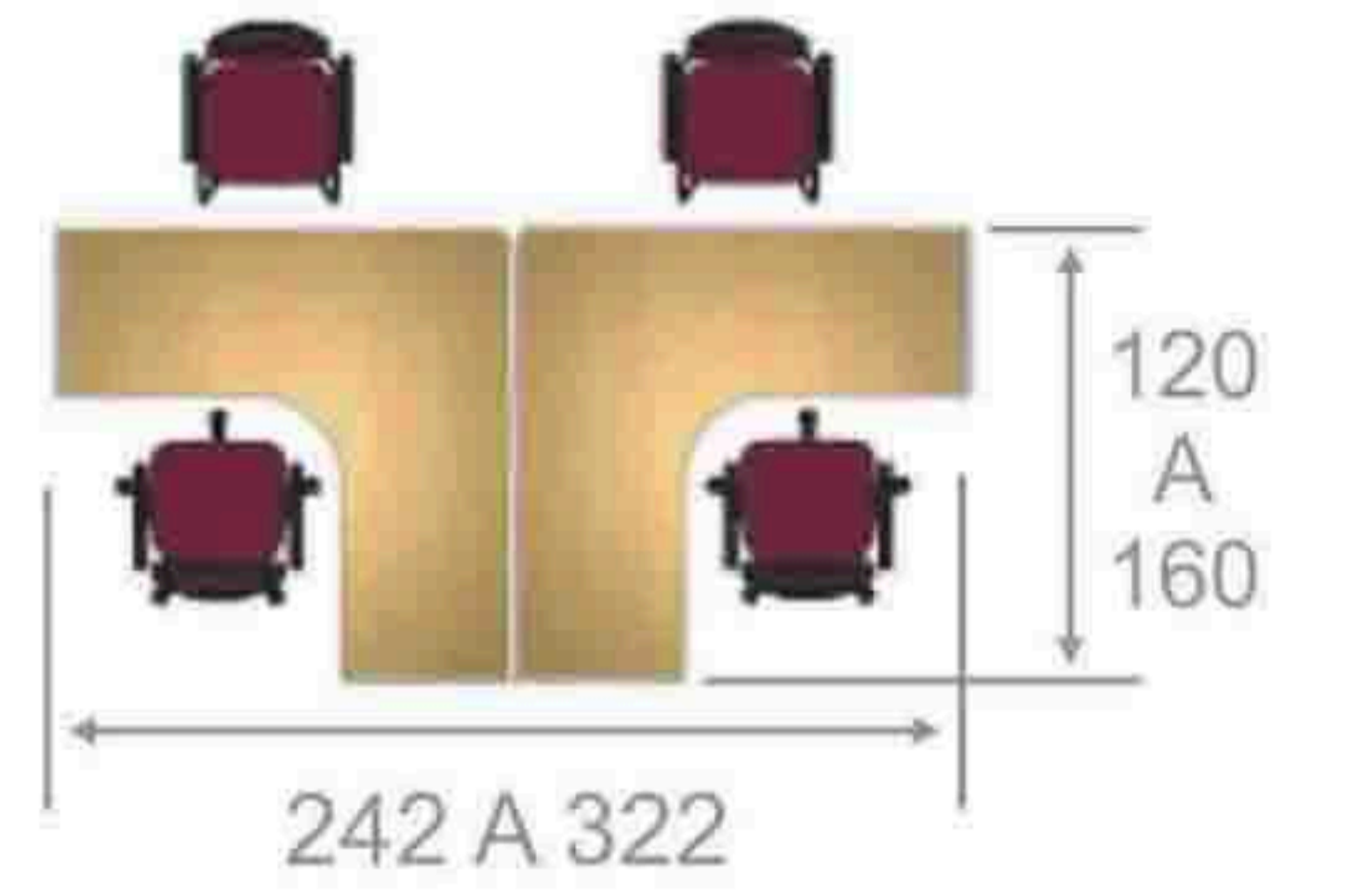
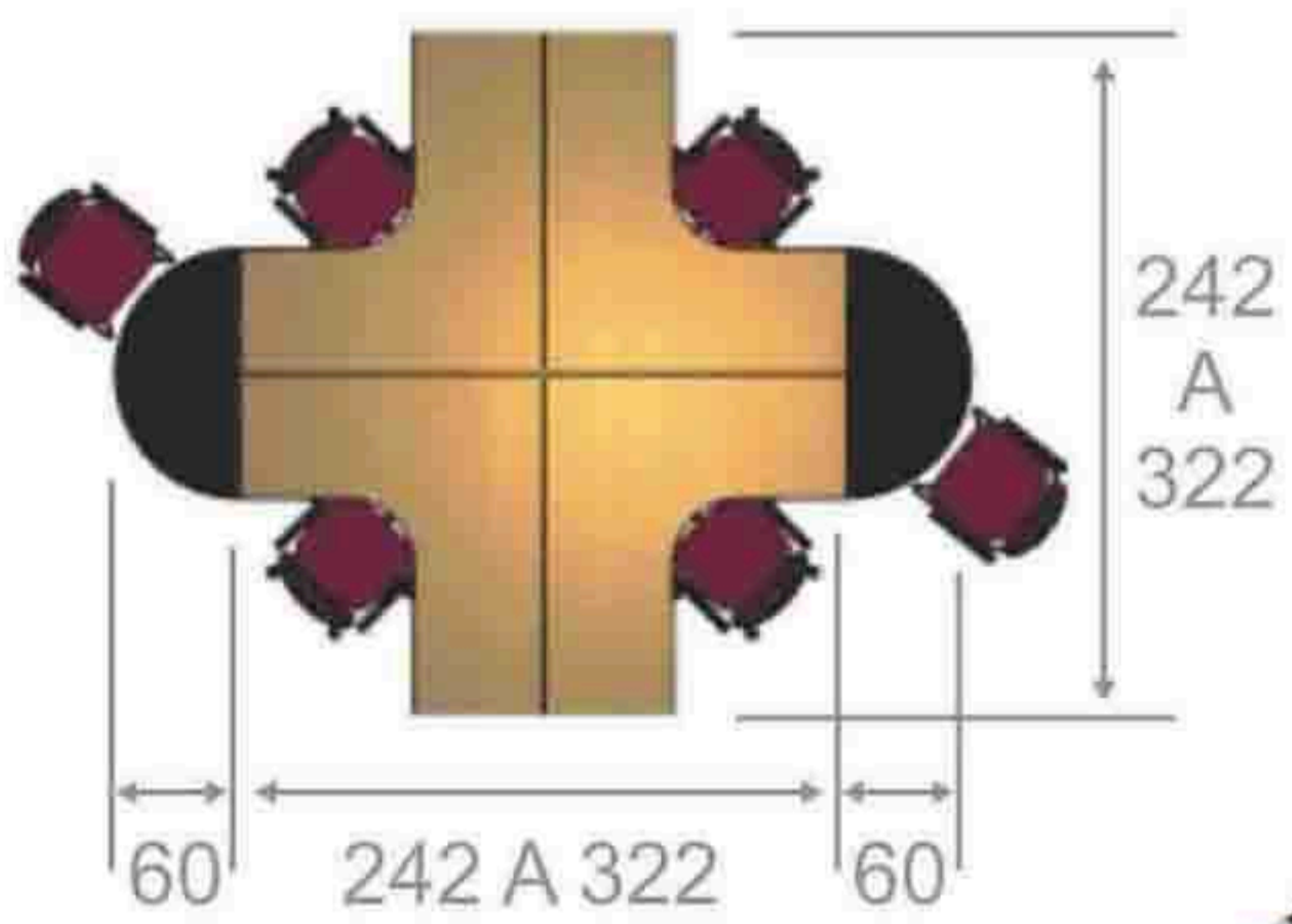

ESTAÇÃO FREE FORMATO I

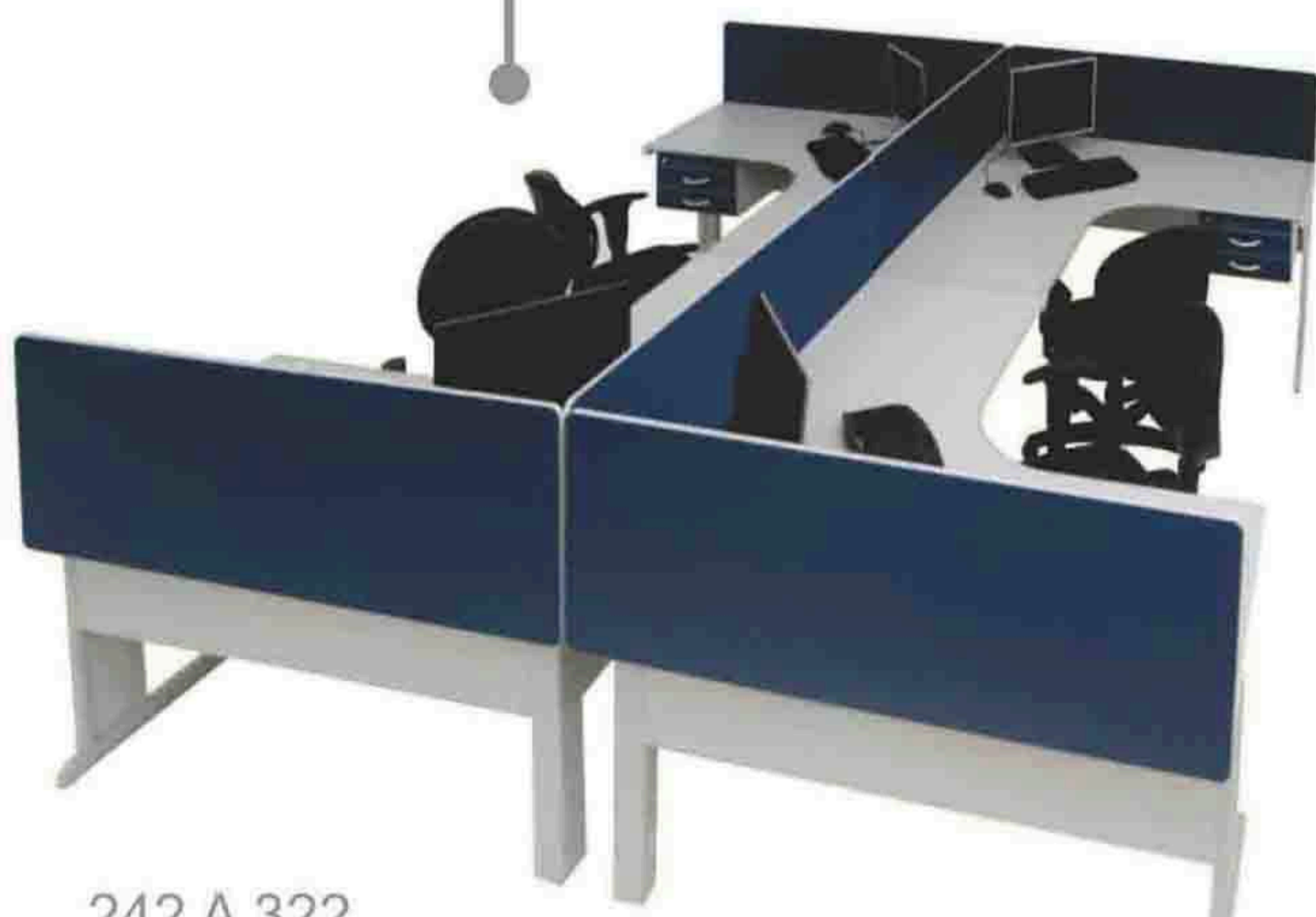

ESTAÇÃO DIX FORMATO QUADRADO

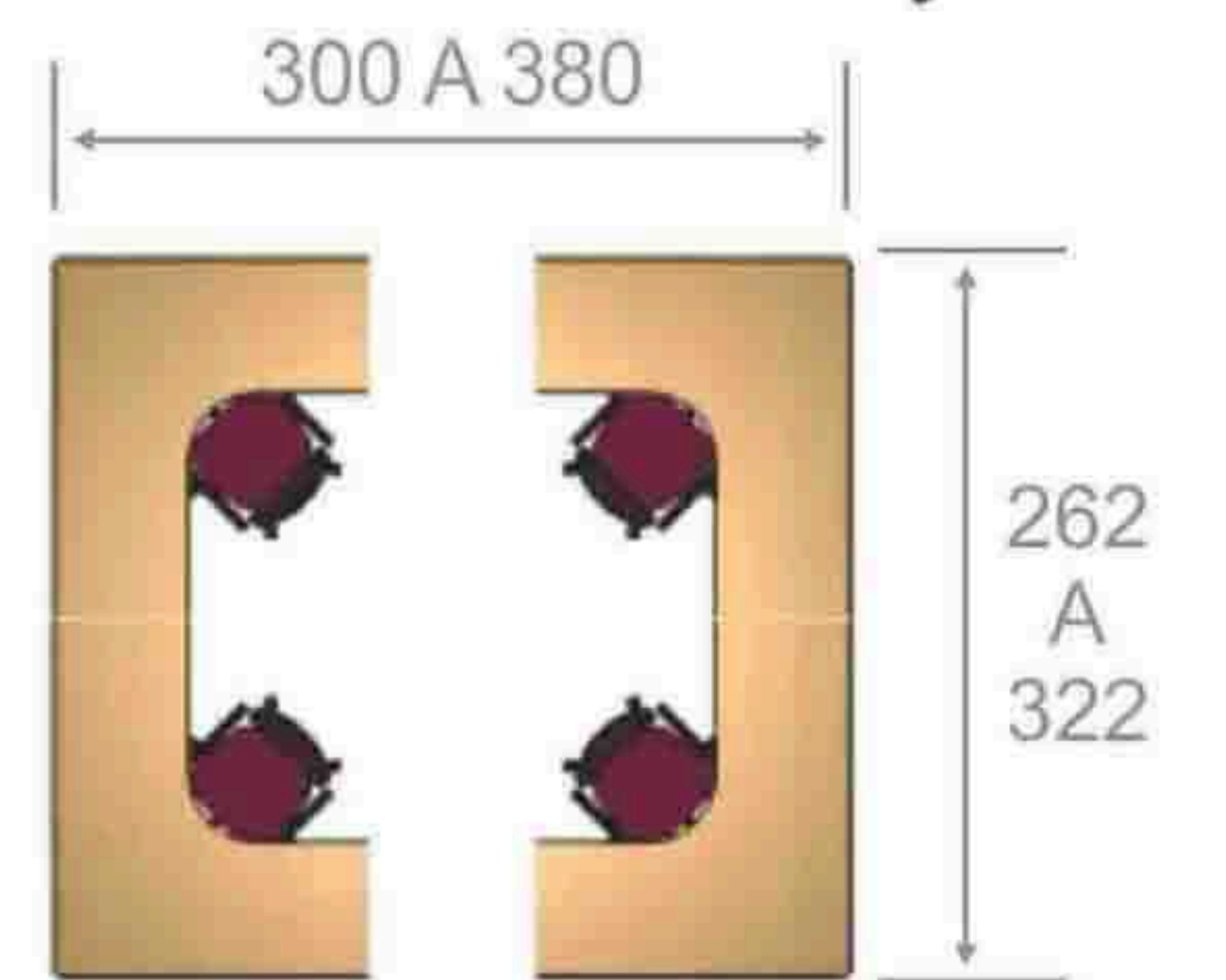
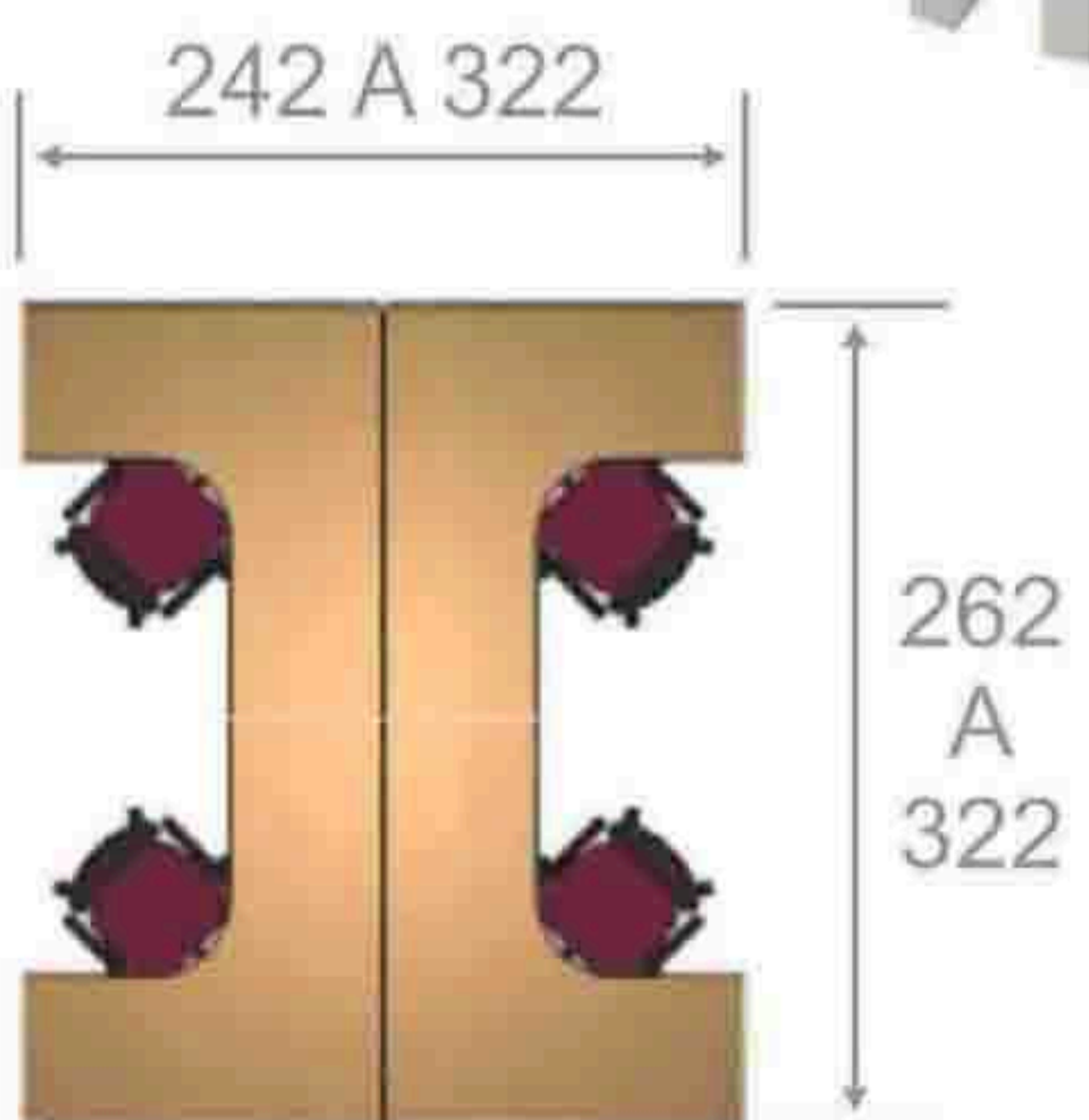

ESTRUTURAS:



COMPONENTES

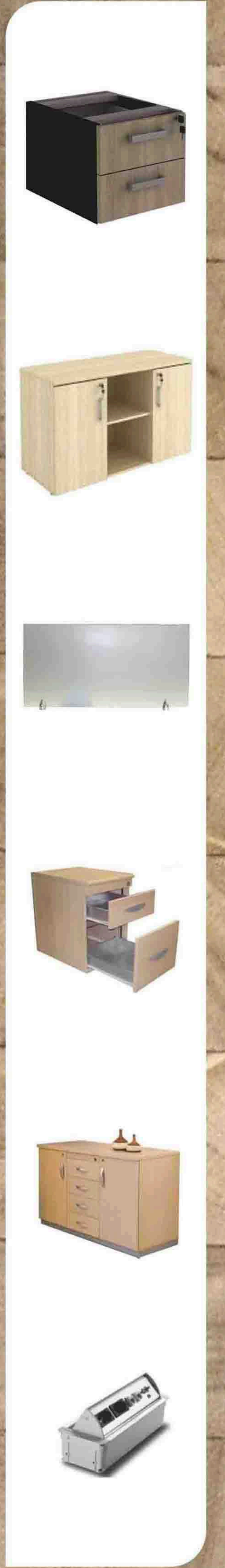
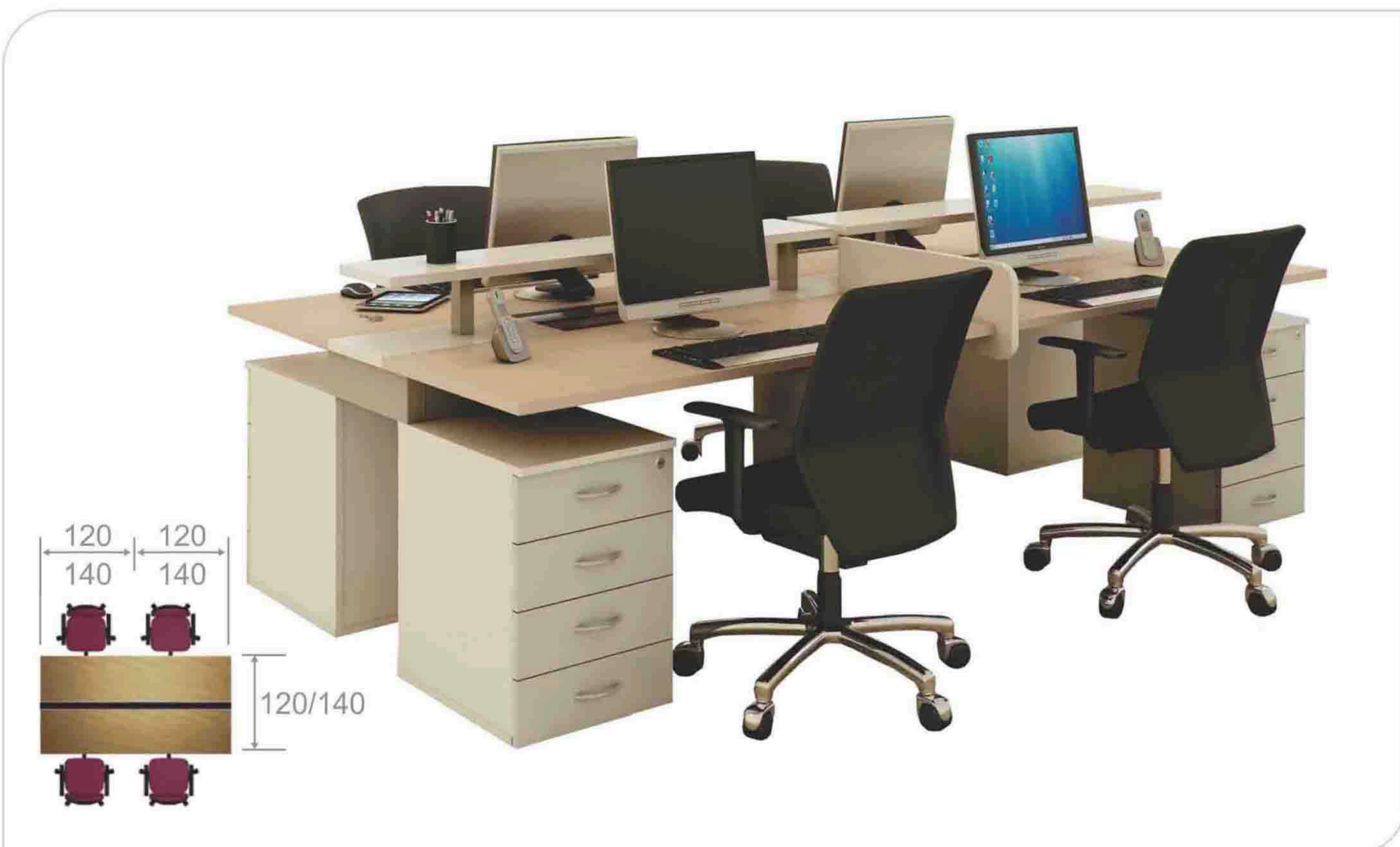



SOFT*



CLIP*



KA*



ONE*



ALFA*



MART*

*As medidas variam de acordo com a linha

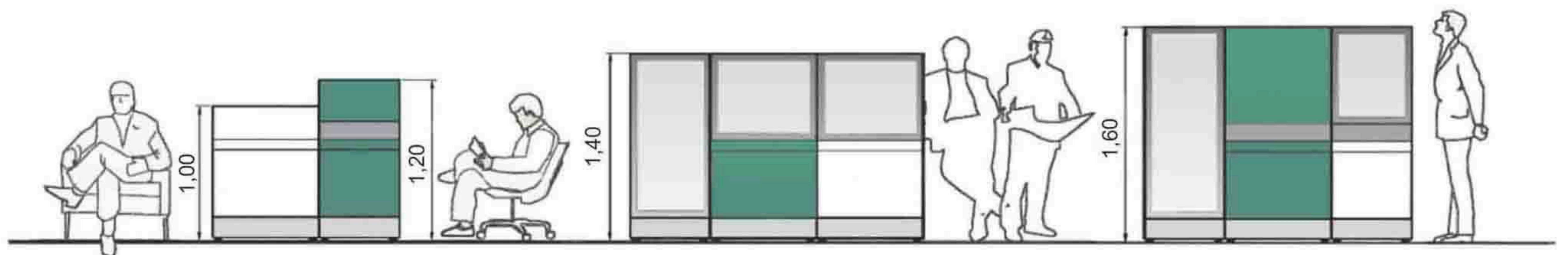



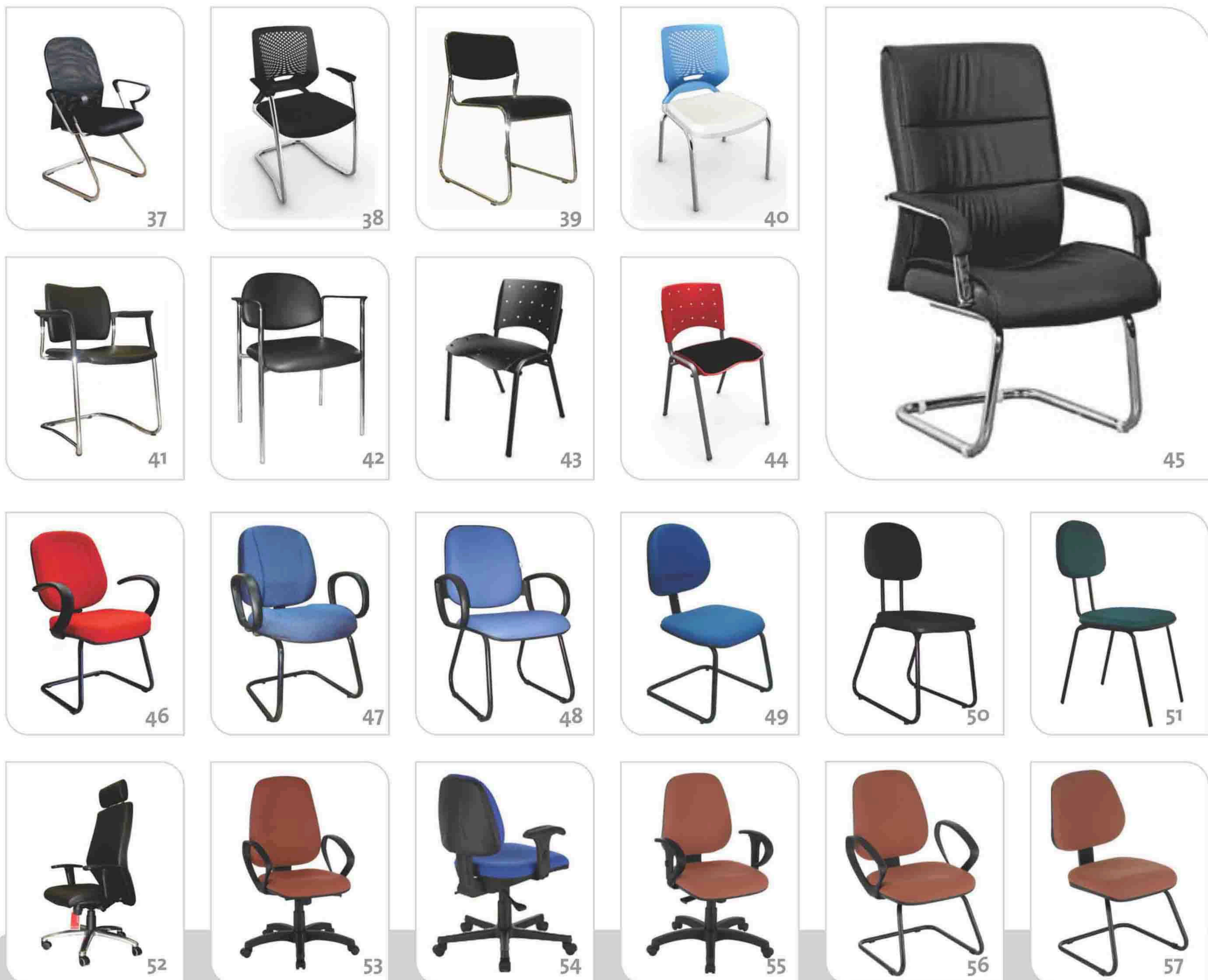

Cadeiras e Poltronas **FLEXFORM**: Empresa pioneira no desenvolvimento de novas tecnologias para poltronas e cadeiras operativas, totalmente em conformidade com as normas ABNT NBR 13962:2002 com garantia de 5 anos (itens 52 a 57).

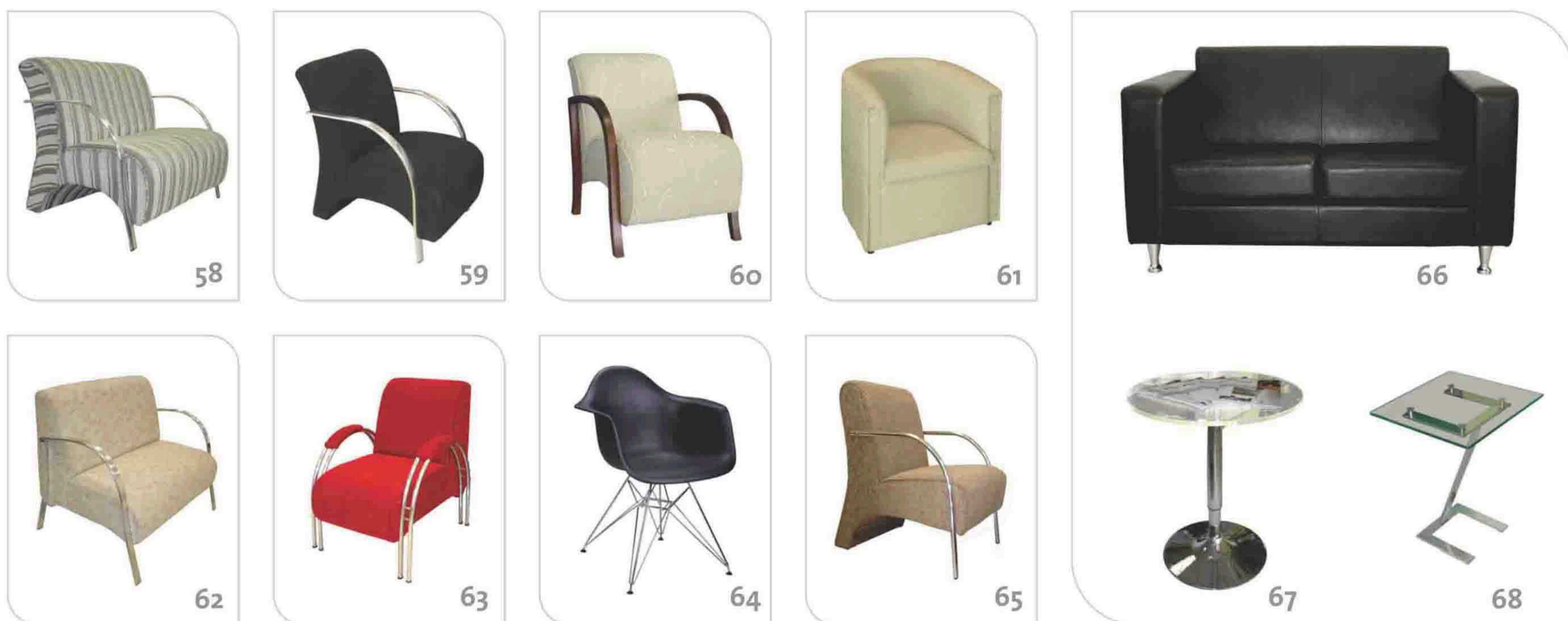

POLIPROPILENO

cadeiras



INDUSTRIAIS

cadeiras



LONGARINAS

cadeiras



UNIVERSITÁRIAS

cadeiras

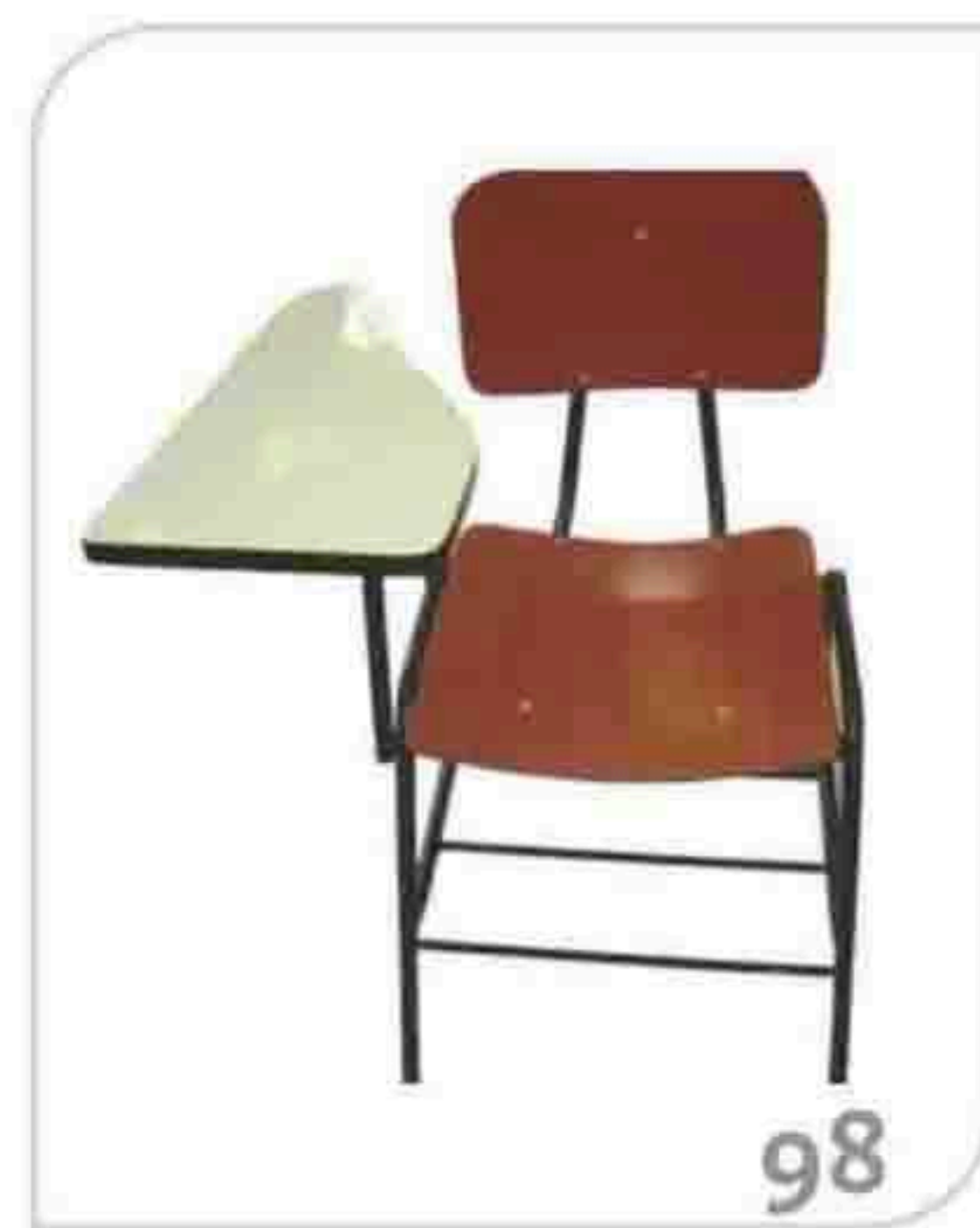



99



100



101



102



103



104



105



106



107

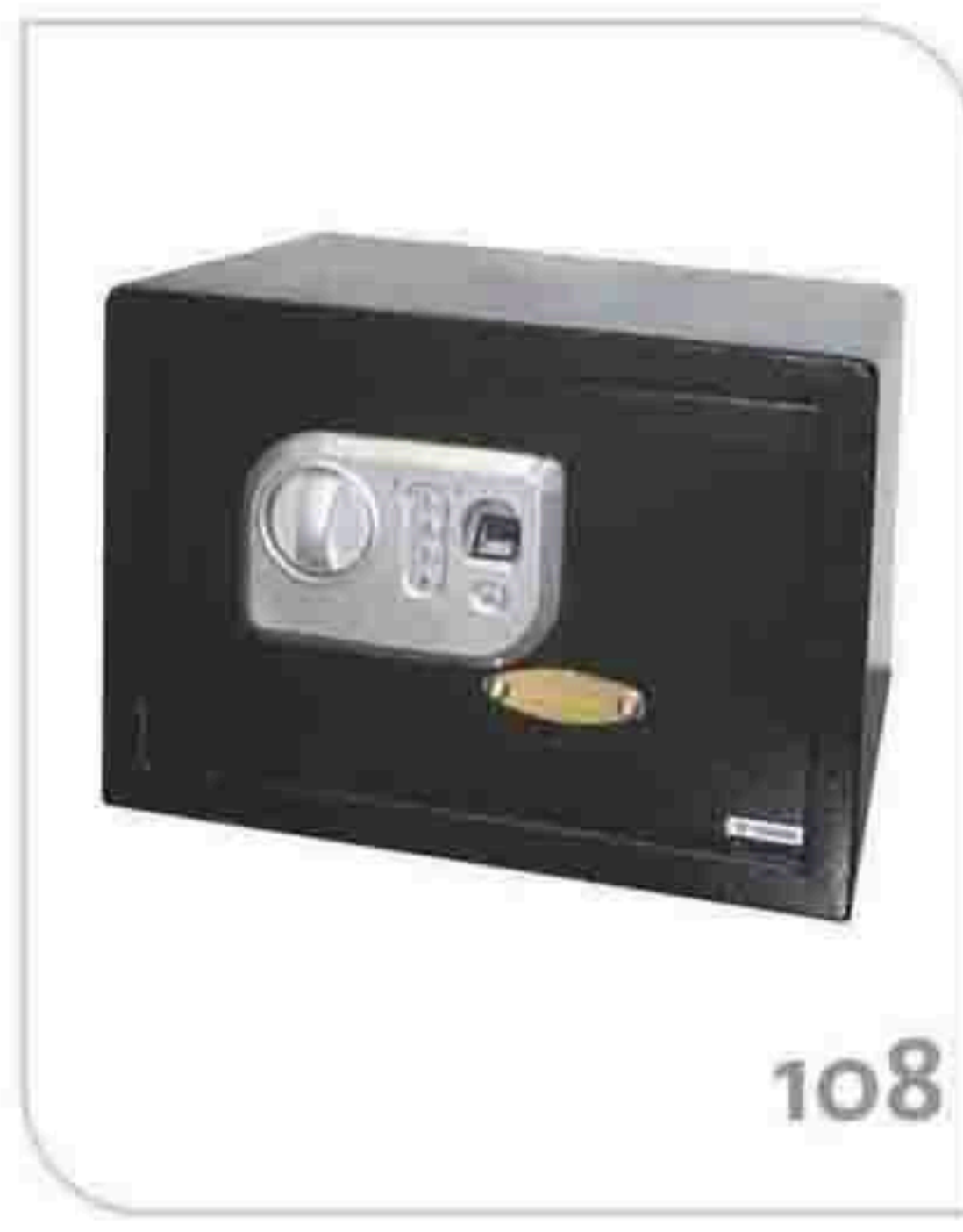

108



109



110



111



112



113



114



115



116



117



118



119



120



121



122



123



GAVETA COM ROLDANAS OU PONTEIRAS DE NYLON



GAVETA COM TRILHO C/ MICRO ESFERAS



GAVETA COM CARRINHO TELESCÓPIO



OF2

OF4



ARQUIVO PARA FICHAS



ARQUIVO COM RODÍZIOS



ARMÁRIO PARA PASTAS



ROUPEIROS

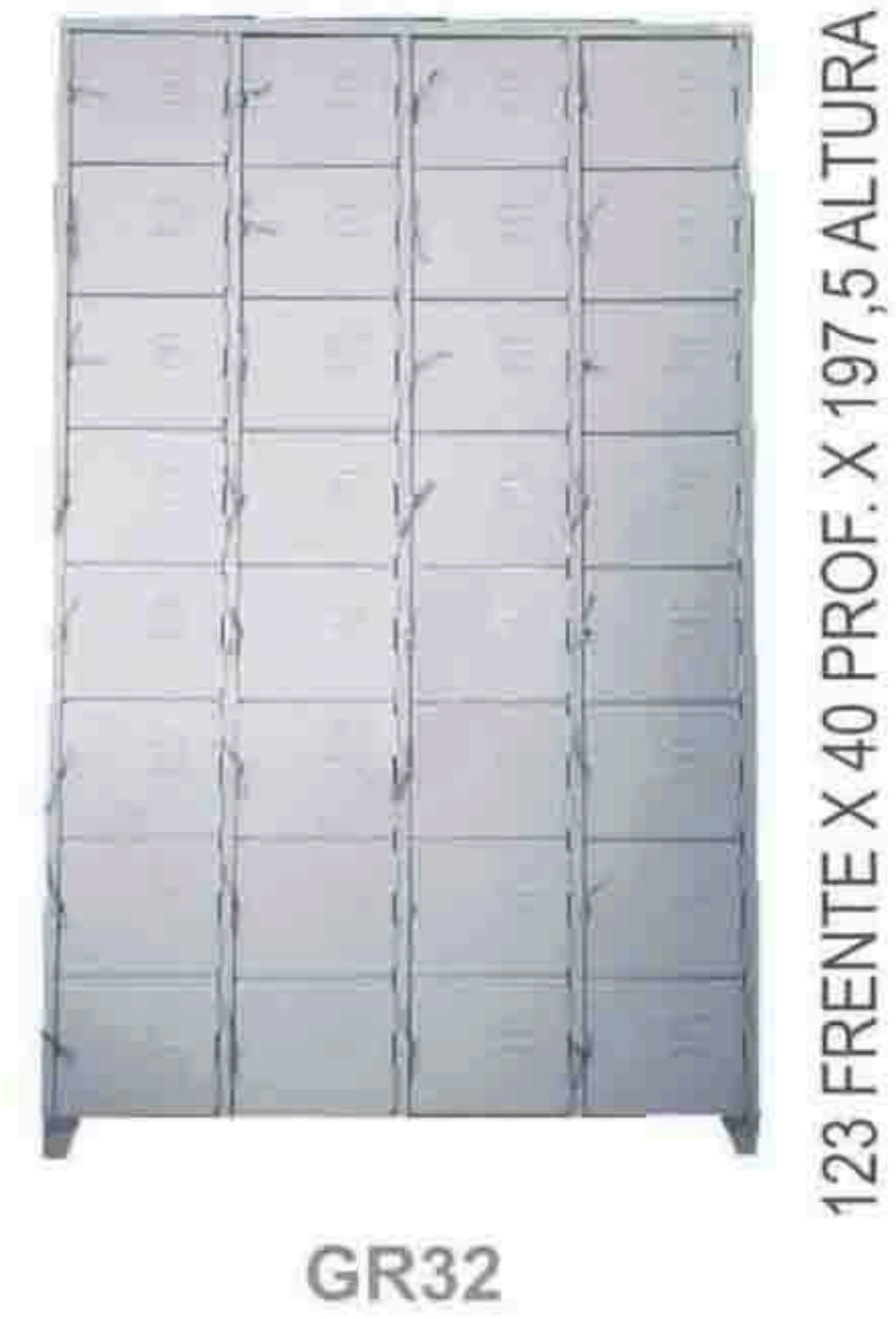
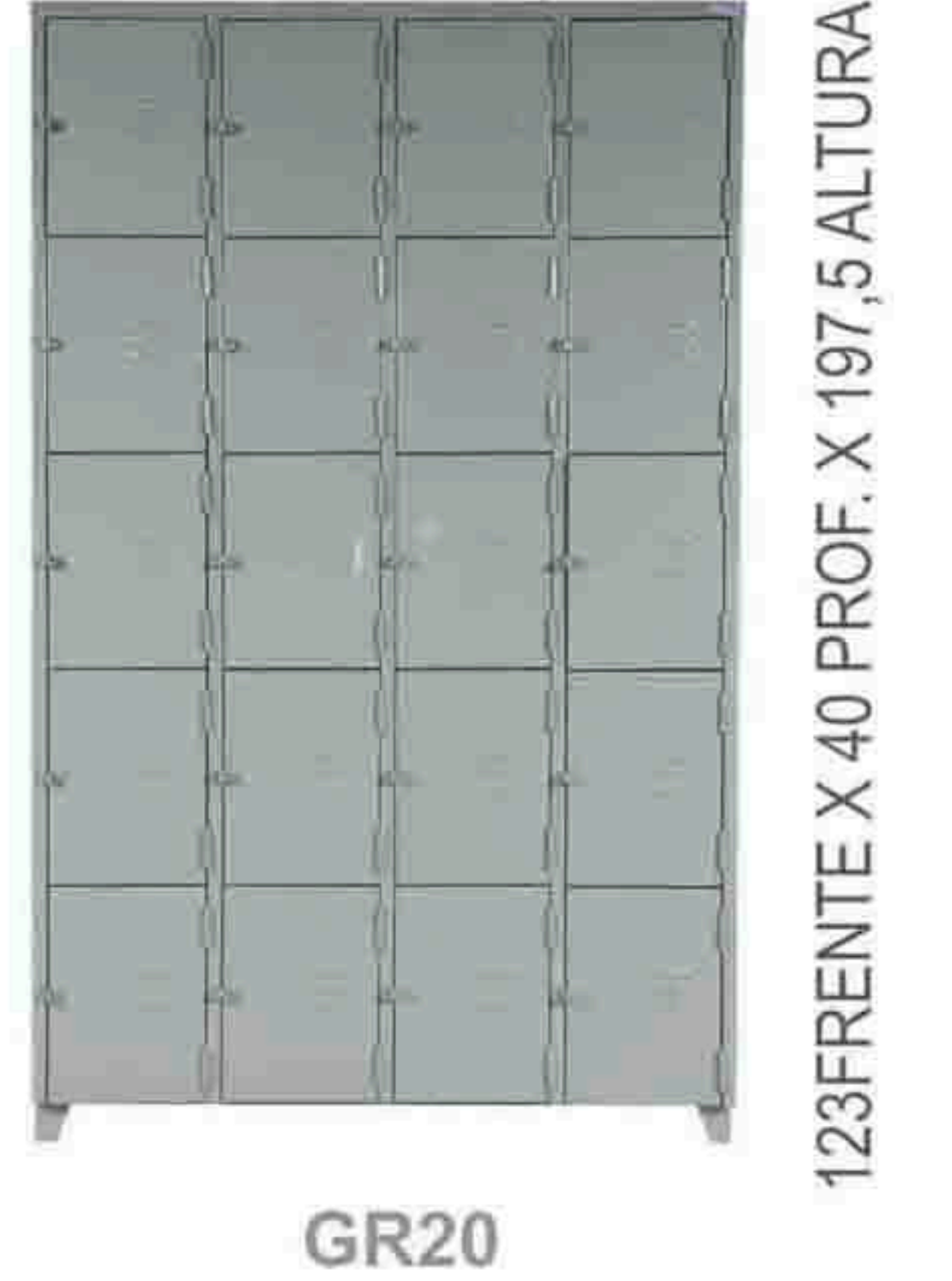
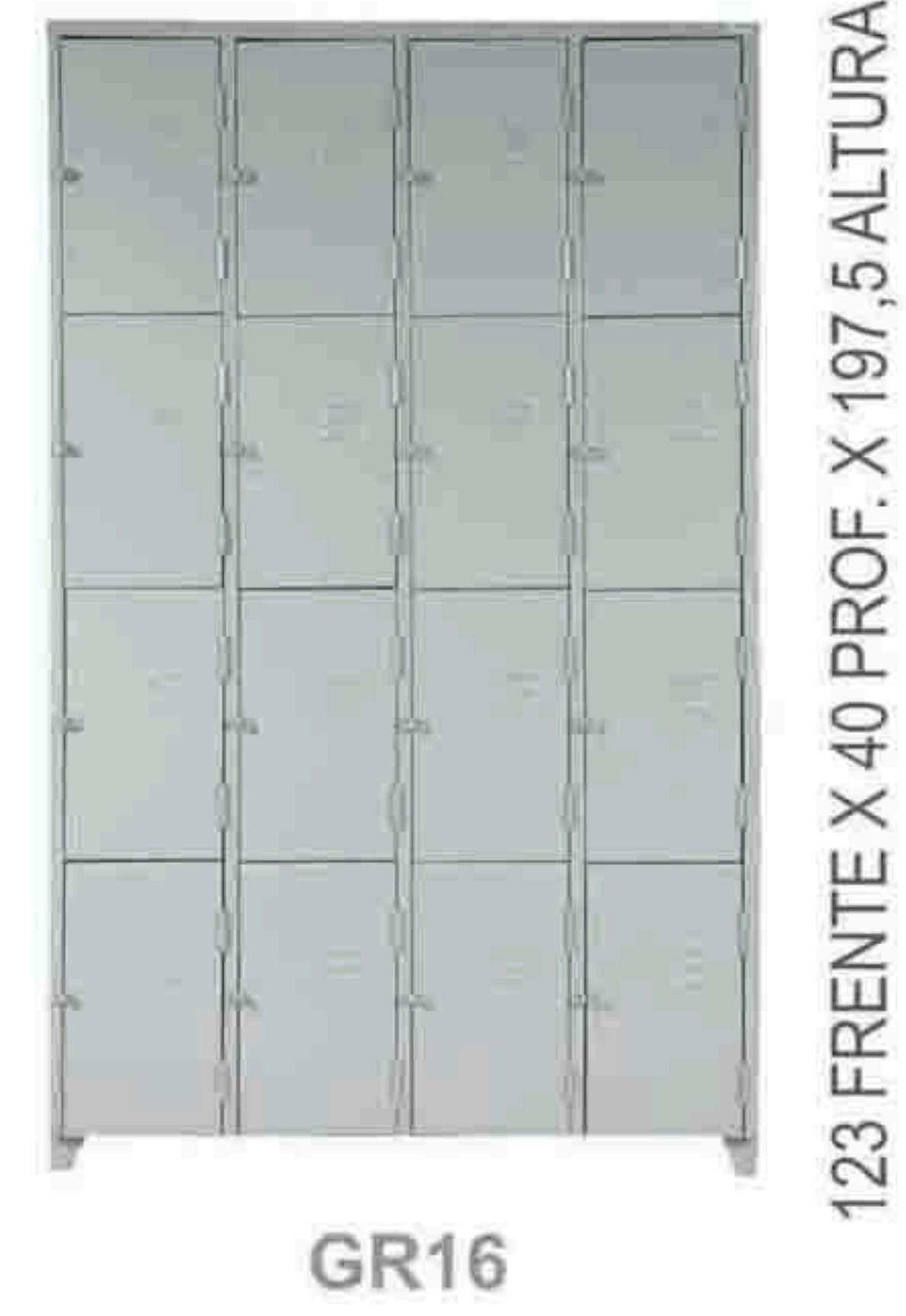
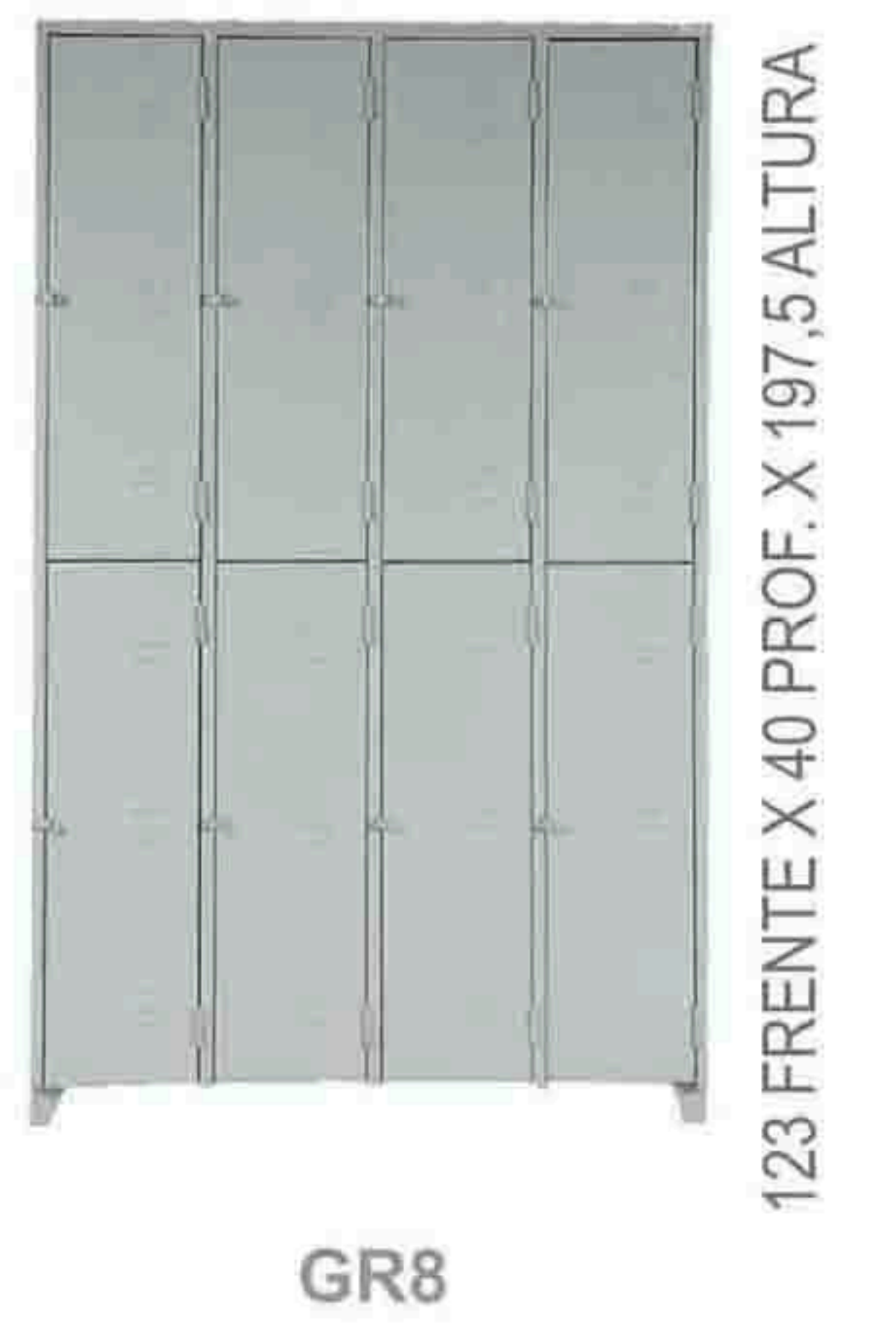
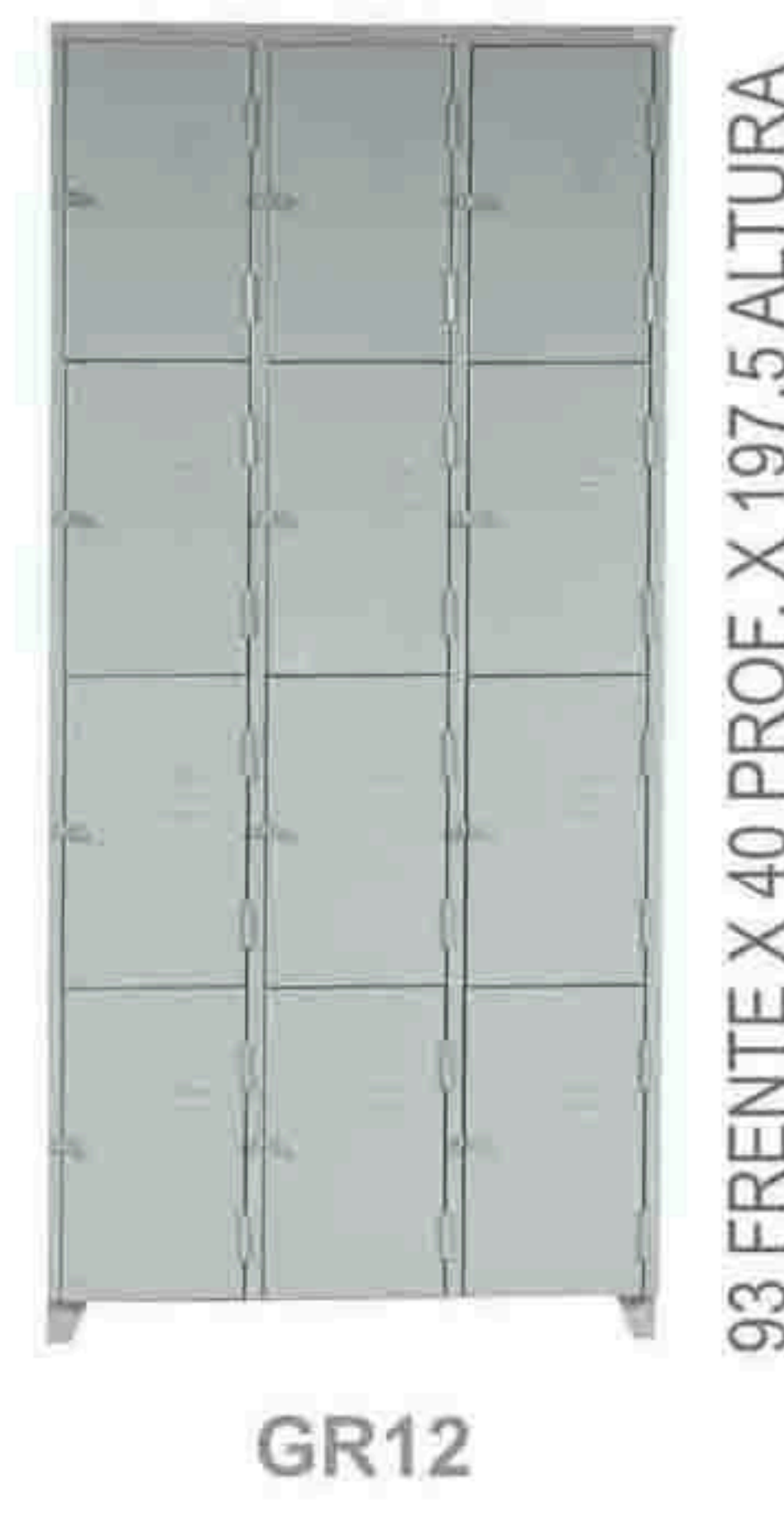
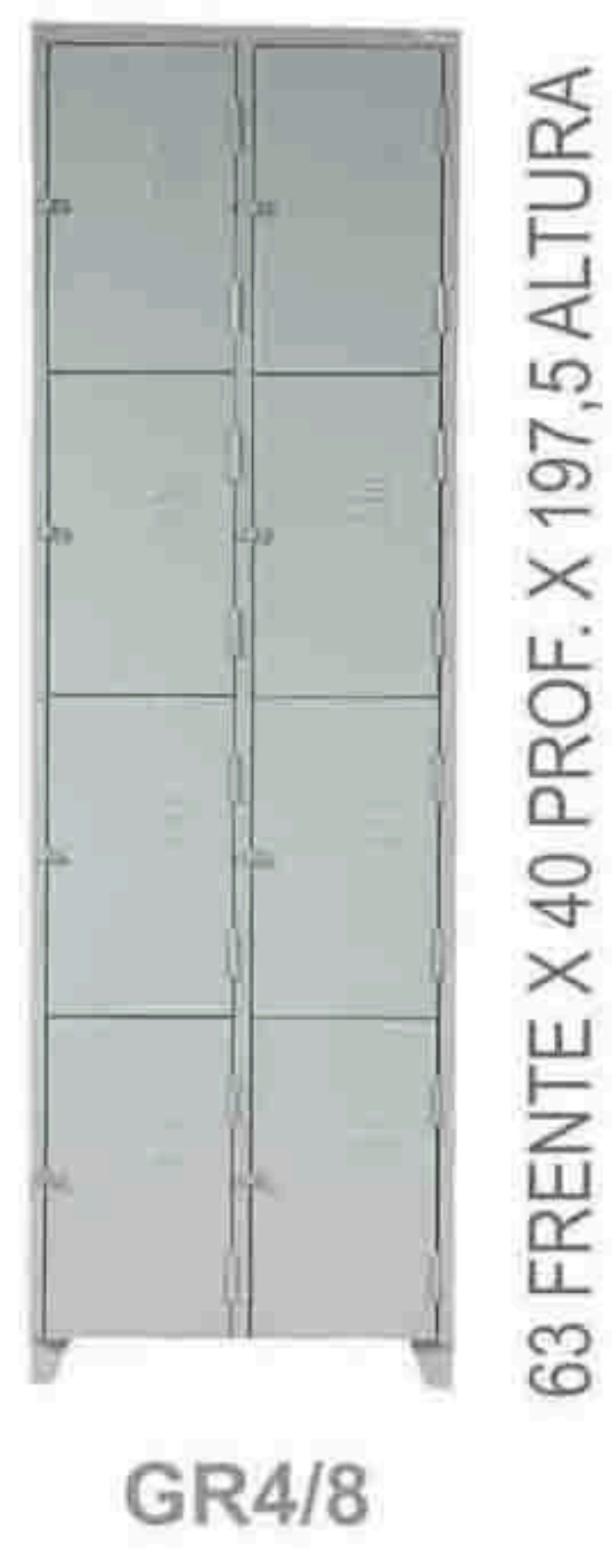
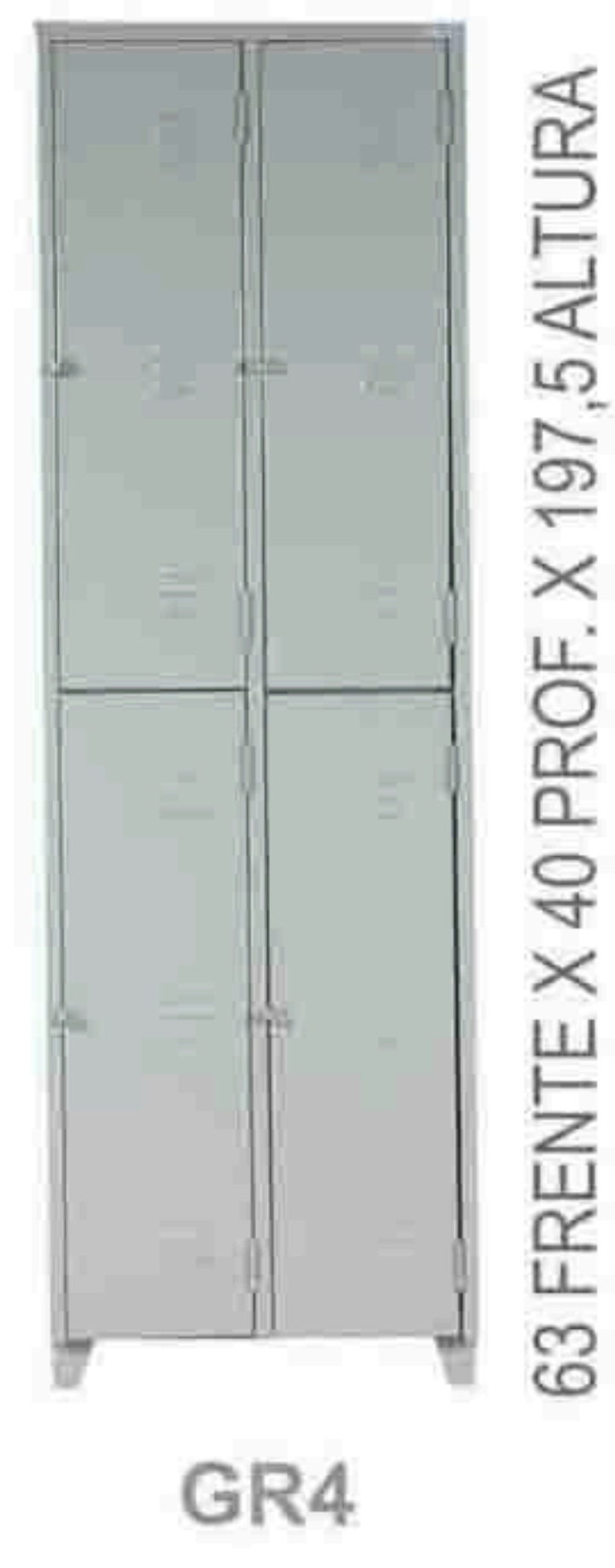
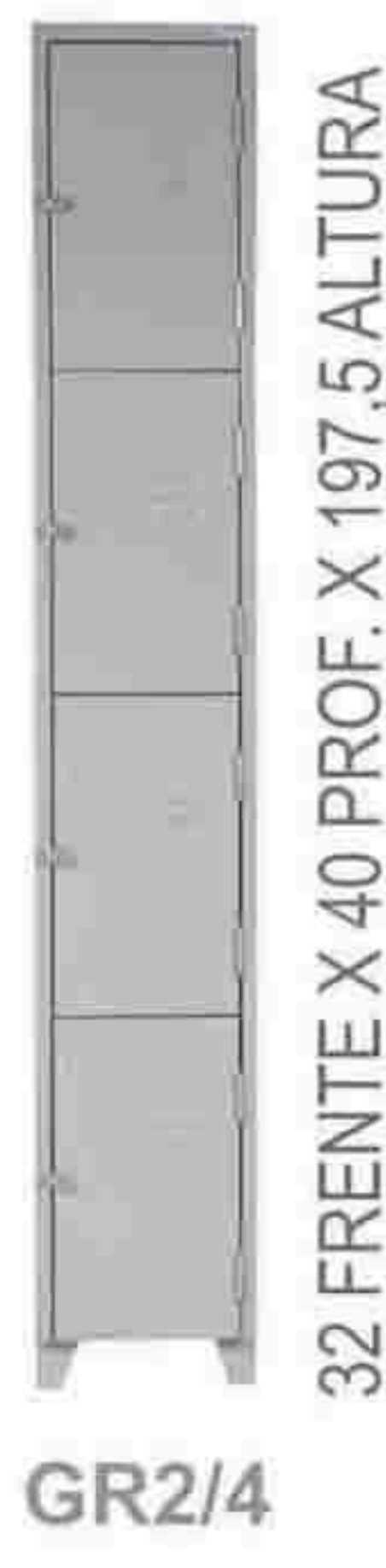
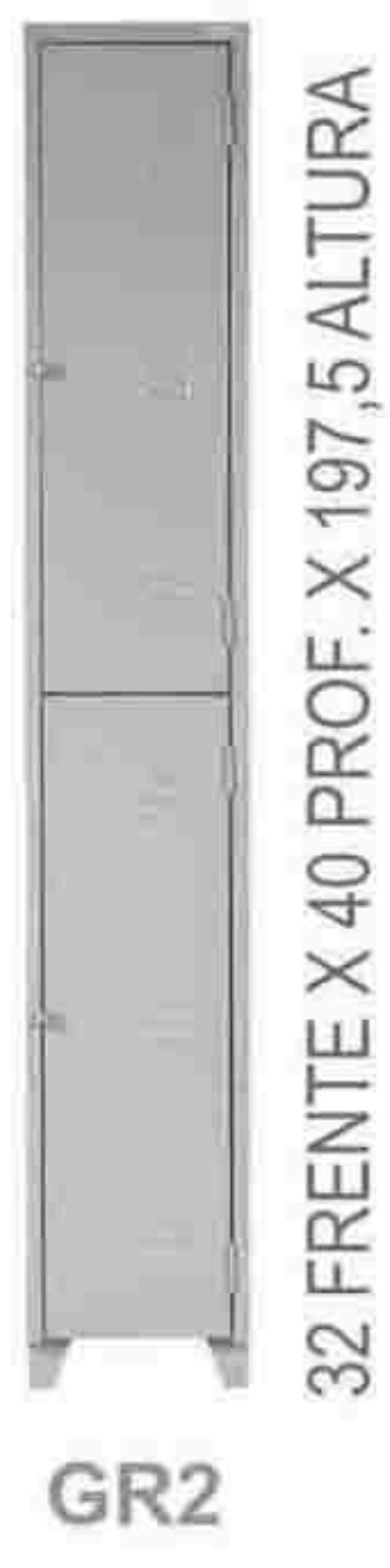

ARMÁRIOS

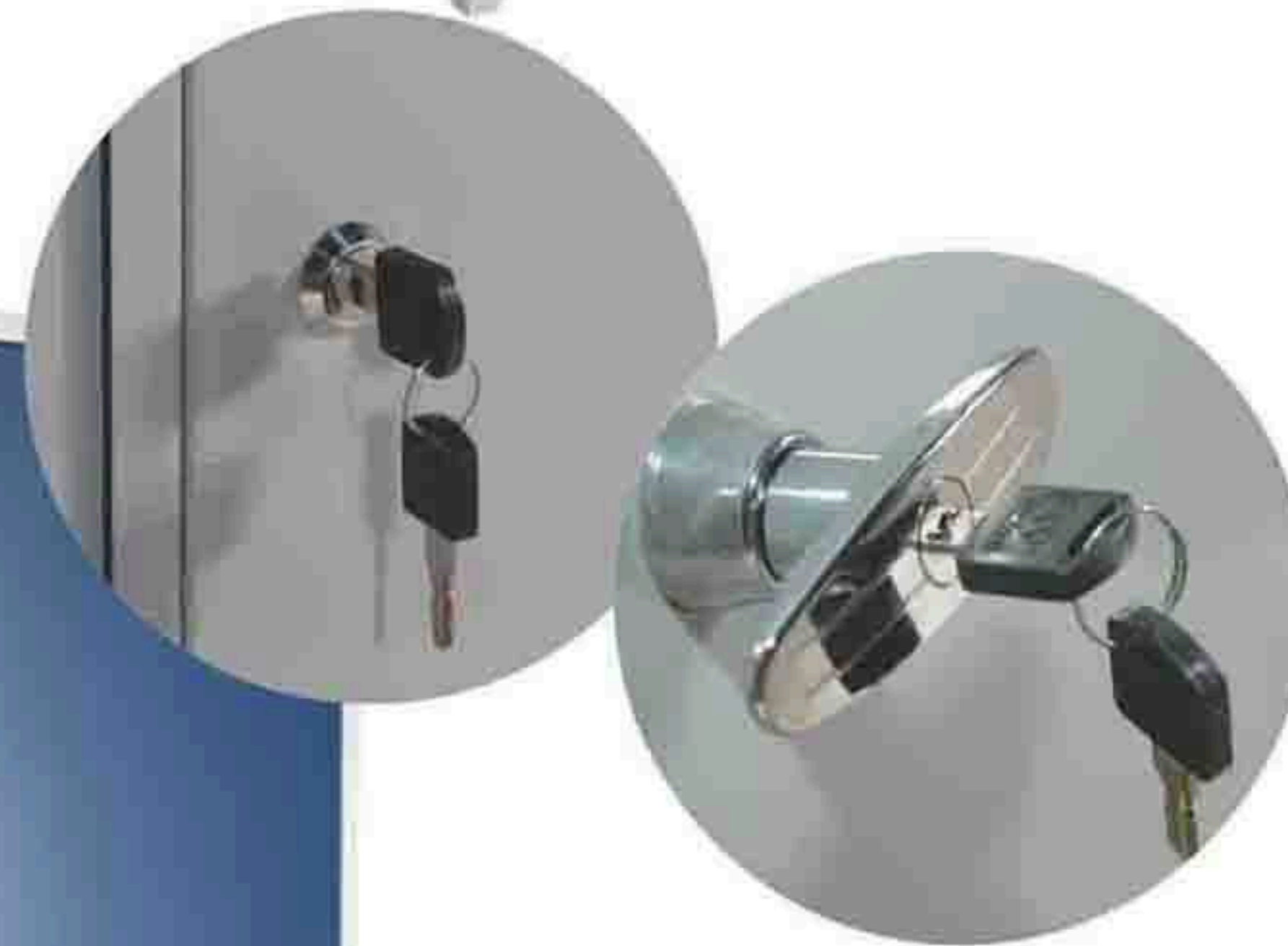

ESTANTES



ESPESSURAS DE CHAPAS - CH 14=1,90MM / CH 16=1,50MM / CH 18=1,20MM / CH 20=0,90MM / CH 22=0,76MM / CH 24=0,60MM / CH 26=0,45MM



TAKAYA EQUIPAMENTOS P/ ESCRITÓRIO LTDA.

AV. PIRAPORINHA, 736 - VILA NOGUEIRA - CEP 09950-000 - DIADEMA - SP

TEL.: (11) 4075-3688 / 4075-3345 - SITE: www.takaya.com.br - E-mail: takaya@takaya.com.br